

Magnetic Fields in Solar System Planets

Dave Stevenson, Caltech

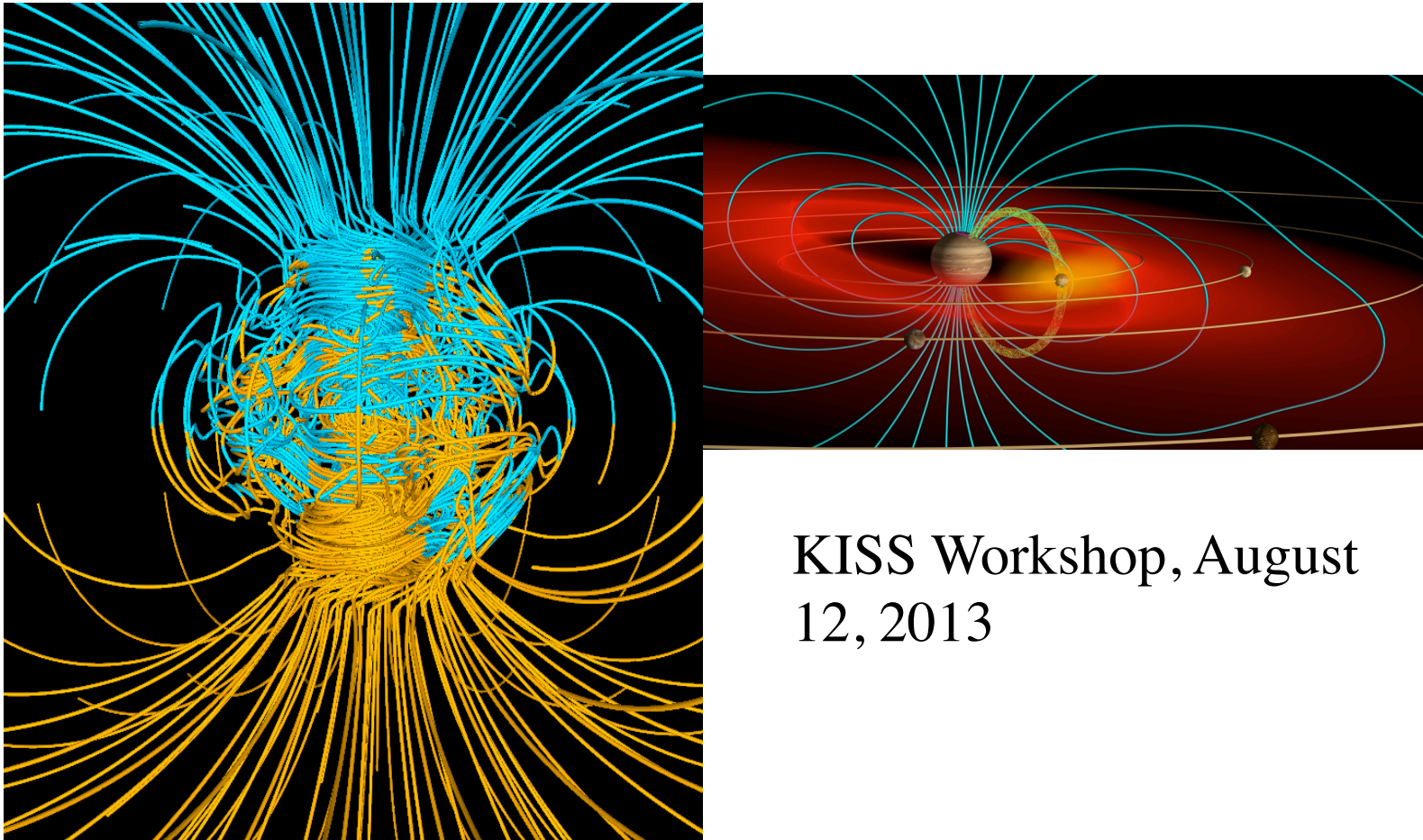

KISS Workshop, August
12, 2013

- Magnetic fields are ubiquitous in the Universe
 - And large in many (most?) stars and planets
 - “large” being defined as \sim Gauss
- Magnetic fields come primarily from currents (motion of charged particles)
 - Charged particles are “everywhere” even though materials are mostly electrically neutral
- Permanent magnetism records the past presence of current-induced fields
 - Requires cold magnetic minerals
- No monopoles

Outline

- Some generalizations about the observations
- What general principles determine whether there is a dynamo?
 - The importance of cooling
 - The importance of LOW thermal and electrical conductivity
 - The unimportance of rotation?
- What general principles govern the geometries, stabilities and magnitudes of the observed fields?

Four Categories of Fields

- Large Fields , predominantly dipolar
Earth, Ganymede, Jupiter, Saturn, Mercury
- Large Fields, predominantly non-dipolar
Uranus, Neptune
- Small Fields arising from Crustal magnetism; possible past dynamos
Moon, Mars, some asteroids, Venus?
- Small fields arising from induction (time-varying external field)
Io?, Europa, Callisto

Large, Global Fields, Predominantly Dipolar

“Large” means ~1Gauss typically, at the inferred conducting region

	B (Gauss)	Dipole Tilt(°)	Quad/Dipole
Earth	0.5 (surface)	~10°	~0.2 (core)
Jupiter	4.2 (surface)	~10°	~0.2 (core)
Saturn	0.2 (surface) ~2 (core)	~0°	~0.2 (core)
Ganymede	0.02 (surface), ~1 (core)	~10°?	Not known (no evidence)
Mercury	0.002 (surface)	~2°?	~0.4 (core)

Large, Global fields, Predominantly Non-Dipolar

	B (Gauss)	Dipole Tilt(°)	Quad/Dipole
Uranus	~0.4 (surface)	~50°	~1(surface)
Neptune	~0.4 (surface)	~50°	~1(surface)

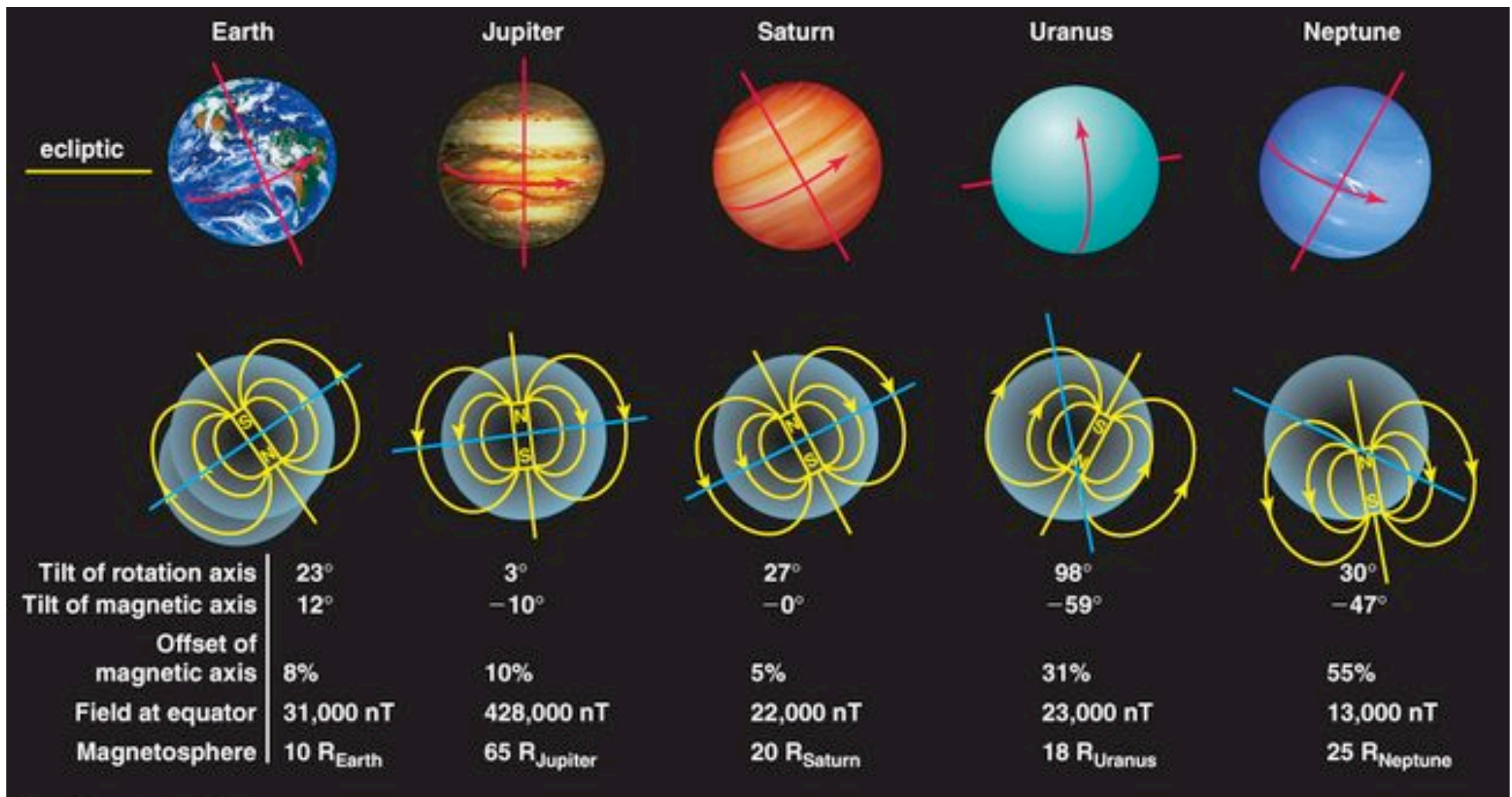

General Guiding Principles

- Convection (compositional or thermal) is the primary method for providing large fields through dynamo action
- The energy budget for sustaining convection is often marginal in terrestrial planets.. A substantial heat flow is possible from conduction alone.
- High electrical conductivity is a disadvantage in these bodies because it implies (through the Wiedemann-Franz relation) a high thermal conductivity, which can kill convection
- There is no corresponding concern for giant planets

Essential Features of a Dynamo

Relevant equation for magnetic field \mathbf{B} is

$$\partial \mathbf{B} / \partial t = \lambda \nabla^2 \mathbf{B} + \nabla \times (\mathbf{v} \times \mathbf{B})$$

λ = magnetic diffusivity = $1 / \mu_0 \sigma$

\mathbf{v} = fluid motion relative to rigid rotation

Fluid motion is important provided $R_m \equiv vL / \lambda > \sim 10$

Then *perhaps* a field is sustained.

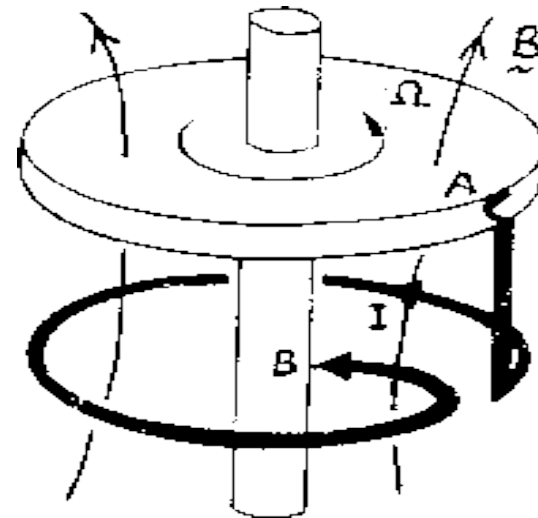

In this mechanical analog (the disk dynamo) the emf created by disk rotation creates a current that produces the field responsible for the emf.

What is (usually) needed for a Planetary Dynamo?

- Fluid conducting region in differential motion.
 - Dynamo region does not have to be the core but outer regions of planets are usually insulating. Hot Jupiters may be an exception.
- Convection is the likely source of the necessary vertical motions.
- The driver for convection is usually cooling
 - Cores usually have no intrinsic heat sources
 - Cooling may provide thermal buoyancy; often provides compositional buoyancy

Dynamo Operating Conditions (Terrestrial Example)

For *convective heat flows* of ~ 10 mW/
 m^2 , mixing length theory predicts
convective velocities

$$v \sim 10^{-4} \text{ to } 10^{-3} \text{ m/sec}$$

For liquid iron, the magnetic diffusivity
is

$$\lambda \sim 1 \text{ m}^2/\text{sec}$$

The lengthscale of motions and field
structure is plausibly

$$L \sim 10^6 \text{ m}$$

$$R_m \sim 10^2 \text{ or even } 10^3$$

For rotation rates, $\Omega \sim 10^{-4} \text{ s}^{-1}$ (Earth),
 10^{-6} (Venus)

$$R_o \equiv v/2 \Omega L \sim 10^{-4} \text{ to } 10^{-6}$$

So why does Venus have no field?

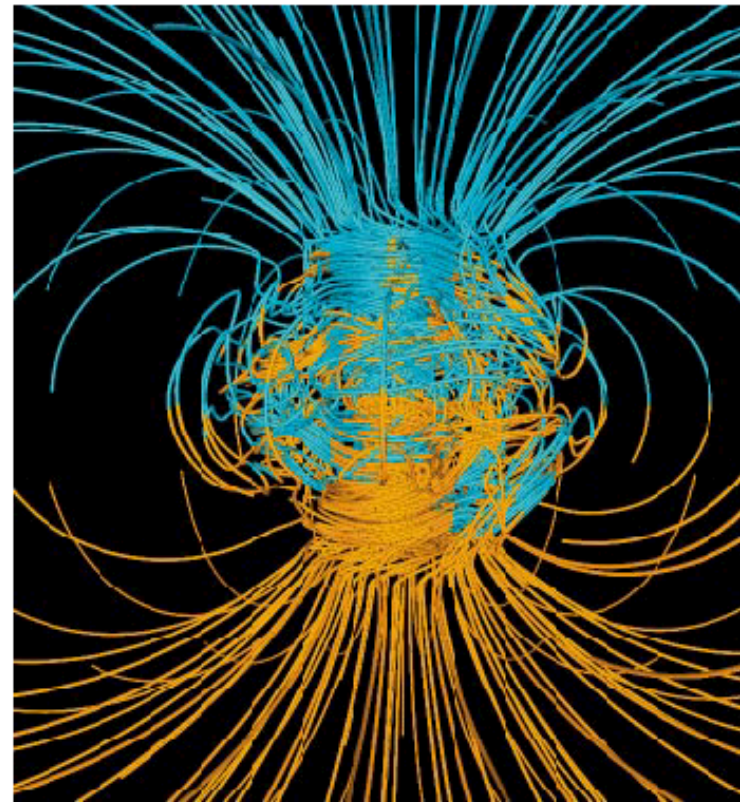

Glatzmaier & Roberts geodynamo

The Central Role of Cooling

- In a homogeneous body, thermal convection requires core heat flow F

$$F > k(\alpha T g / C_p) = F_{\text{cond}}$$

If the thermal conductivity k is high then this can be a problem!

Example: Earth. Current estimated core heat flow along the adiabat by conduction is $\sim 15\text{TW}$. (Total heat flow through Earth's surface is $\sim 44\text{TW}$).

Core cooling is determined by the mantle. Plate tectonics matters!

The Central Role of Cooling

- In a heterogeneous body, you still pay the price of $F_{\text{cond}} = k(\alpha Tg/C_p)$ but the convective heat transport can be downwards because of a larger compositional buoyancy
 - Inner core growth
 - Snow/rain up or down depending on the phase diagram
- Inadequate cooling can turn off a dynamo
- This is a central problem for terrestrial planets; much less important for gas & ice giants.

What about Rotation?

- Dynamo action requires that the characteristic timescale for fluid motions is small compared to the magnetic diffusion time.
 - This timescale is $\sim 3000 \text{yr} \cdot (1 \text{m}^2 \cdot \text{s}^{-1} / \lambda) \cdot (R / 1000 \text{km})^2$
- But such motions are slow compared to rotation timescales even for very slow rotating bodies (e.g. Venus) and so rotation matters in the fluid flow. All planets are fast rotators from the perspective of dynamo theory, including Venus.

What Exactly is the Criterion for a Planetary Dynamo?

- We do not know!
- We suspect it's close to the criterion for convection
 - If the buoyancy flux or heat flow is even mildly in excess of that needed for convection then the resulting convective motions have the requisite magnetic Reynold's number and complexity. But this remains to be quantified properly.
- This is a difficult problem!

What Determines Field Geometry & Stability (AC vs DC, Reversals)?

- Dipole preference in dynamo models is not strong, often absent
- Thickness of convective layer, presence of shearing motions, location of buoyancy sources, nature of boundary conditions can all affect the outcome
- AC (Sun) vs DC + reversals (planets?) is affected by the same factors.

Field Magnitude Scaling?

- Not likely to be very reliable.
 - Jupiter & Saturn differ in field strength by a factor of 20 yet are in many ways similar bodies
 - Mercury field is surprisingly small
 - Inferred paleolunar field is surprisingly large
- There are two kinds of ideas for scaling laws. Both work about equally well in our solar system.
 - Force balance (or convective efficiency arguments)
 - Energy scaling

Field Magnitude Scaling?

- Force balance (Coriolis \sim Lorentz) suggests:

$$\text{Elsasser number } \Lambda \equiv B^2 \sigma / 2\rho\Omega \sim 1$$

- Actual planets satisfy only moderately well

$$\Lambda_{\text{Earth}} \sim \Lambda_{\text{Jupiter}} \sim \Lambda_{\text{Ganymede}} \sim \Lambda_{\text{Saturn}} \sim 0.3, \quad \Lambda_{\text{Uranus}} \sim \Lambda_{\text{Neptune}} \sim 0.1?$$

[based on fields at surface of core region]

- Energy scaling suggests $B^2/2\mu_0 \sim \rho v^2/2$ where v is a convective velocity : $v \sim (LF/\rho H_T)^{1/3}$ where F is the *convective heat flux* (or buoyancy equivalent)
- Evidence supports energy scaling (Christensen) but the story is incomplete

Conclusions & Future Work

- Dynamos are “easy” in giant planets
- Dynamos are “difficult” in terrestrial planets- it is easy to create conditions in which it will turn off.
- Cooling (& its consequences) are crucial
- Diversity more striking than universality
- We still lack a predictive theory! We need:
 - *more relevant numerical & lab simulations*
 - *mineral physics data & simulations*
 - *future space missions, exoplanet observations*

EXTRA SLIDES

Planetary Dynamo Operating Conditions

This shows the consequences of the requirement that the conductivity be neither too large nor too small

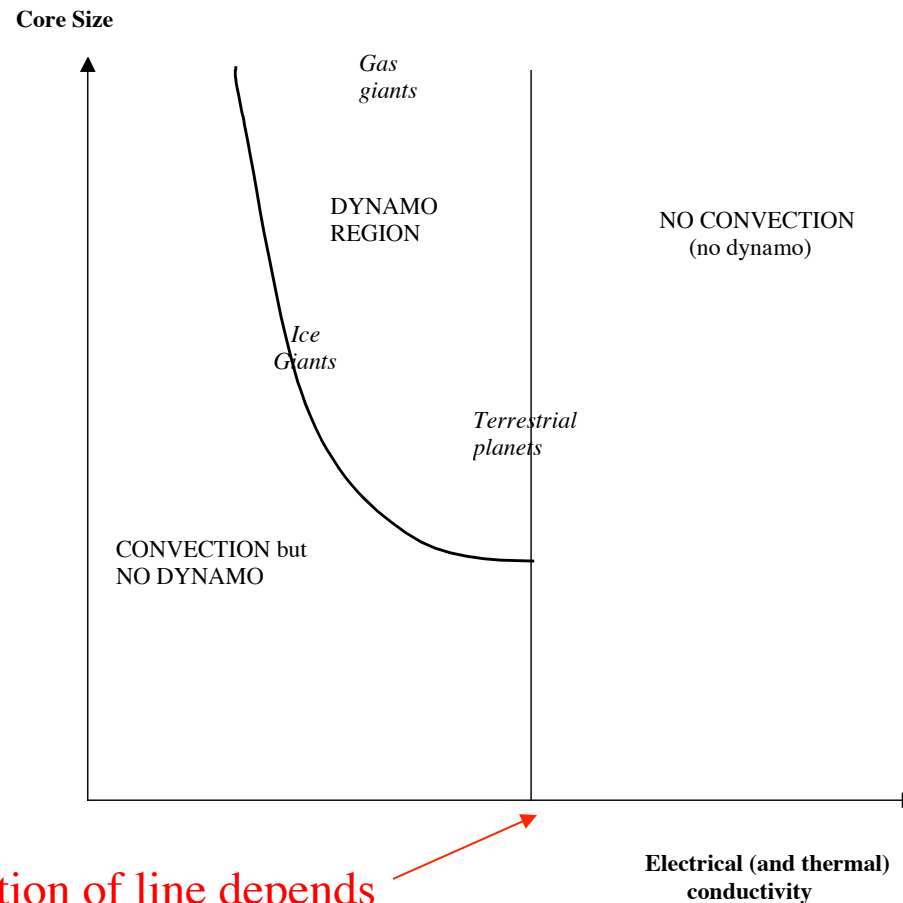

Location of line depends on cooling history

Electrical (and thermal) conductivity

Dynamo Criterion is Close to Convective Onset?

This shows that the magnetic Reynolds number rises rapidly once the criterion for convection is satisfied.

$$x = R/R_{\text{earth}}$$

$R_{m,ml}$ is the value based on mixing length theory, for which $v_{\text{conv}} \sim (FL/\rho H_T)^{1/3}$

$R_{m,mac}$ is based on magnetostrophic balance, so $v_{\text{conv}} \sim (F/\rho\Omega H_T)^{1/2}$

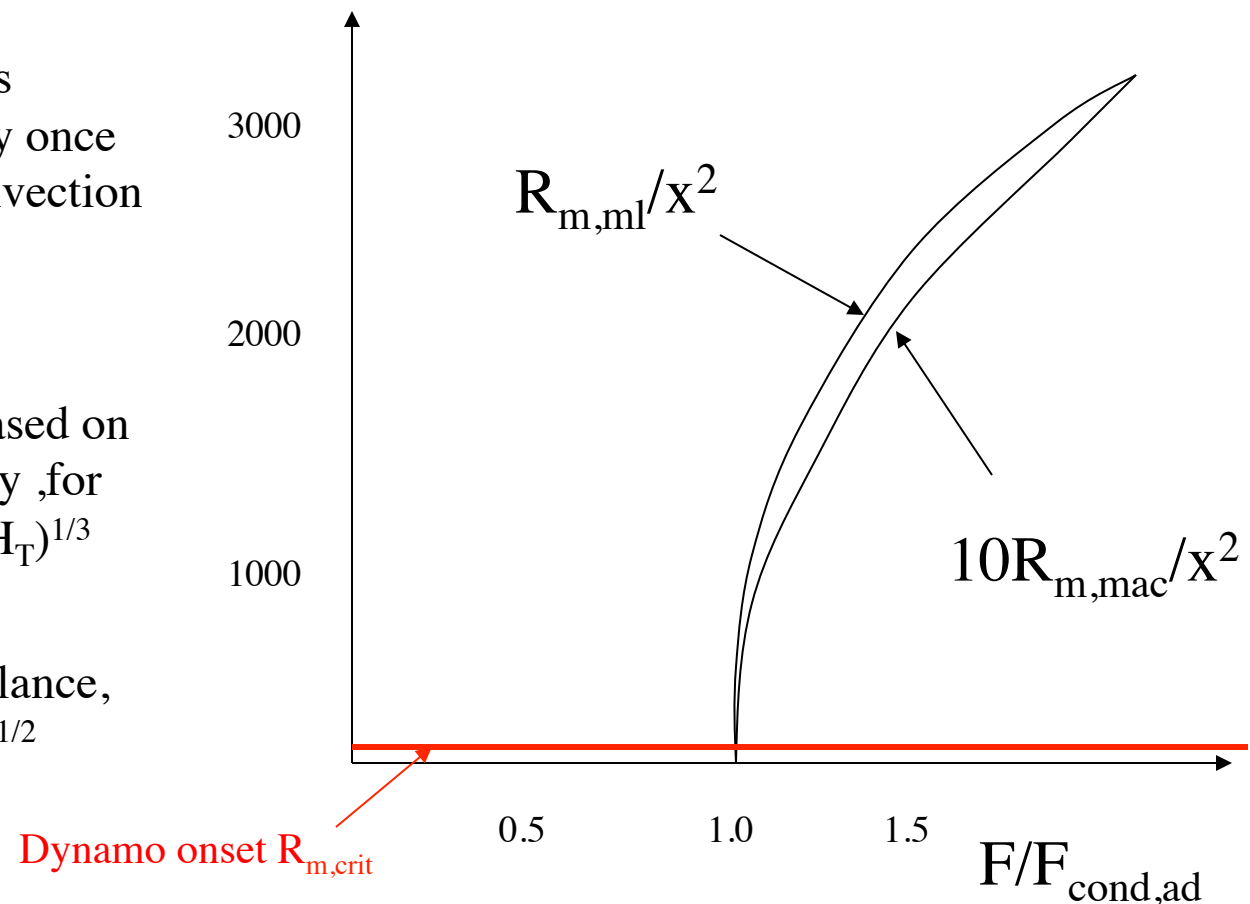

Mercury

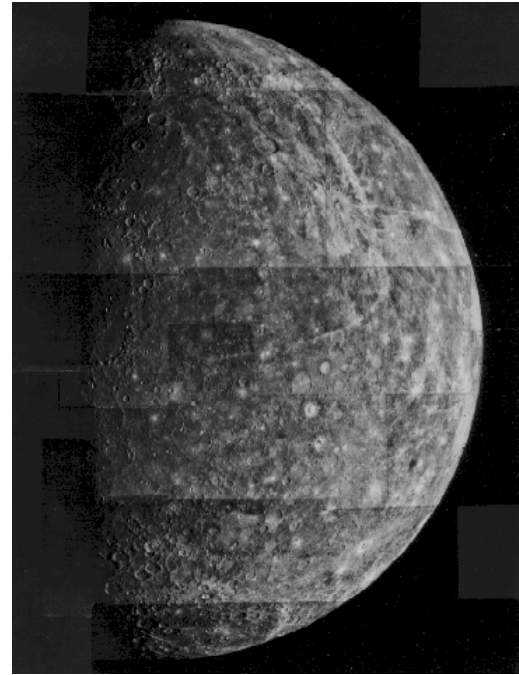

1. Large core.
2. Radar data on libration indicate a liquid outer core.

(Margot et al, 2007)

3. Thermal evolution models suggest it may be mostly frozen by now.

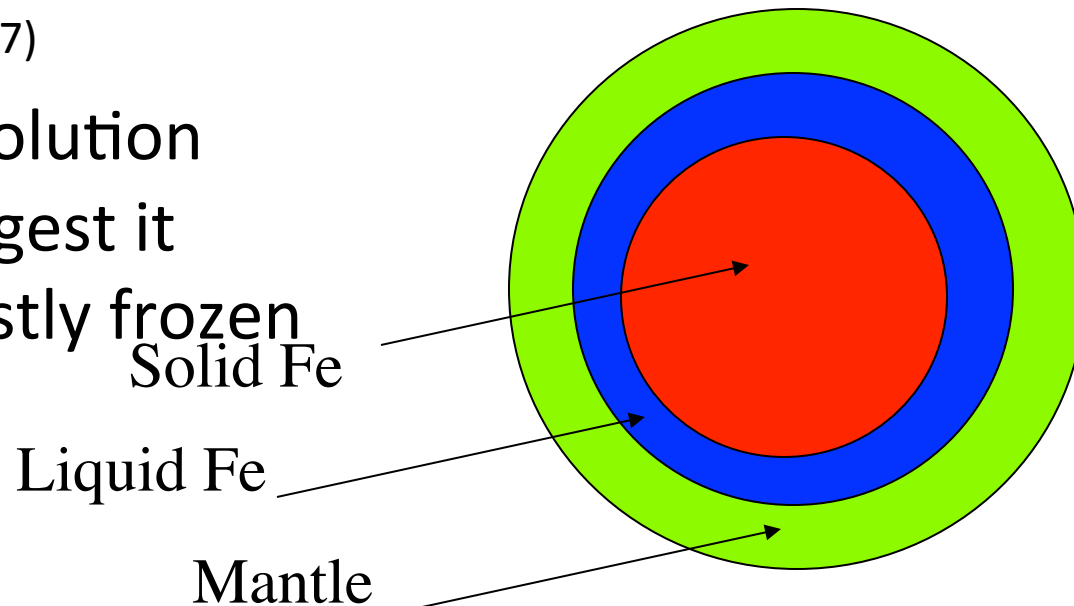

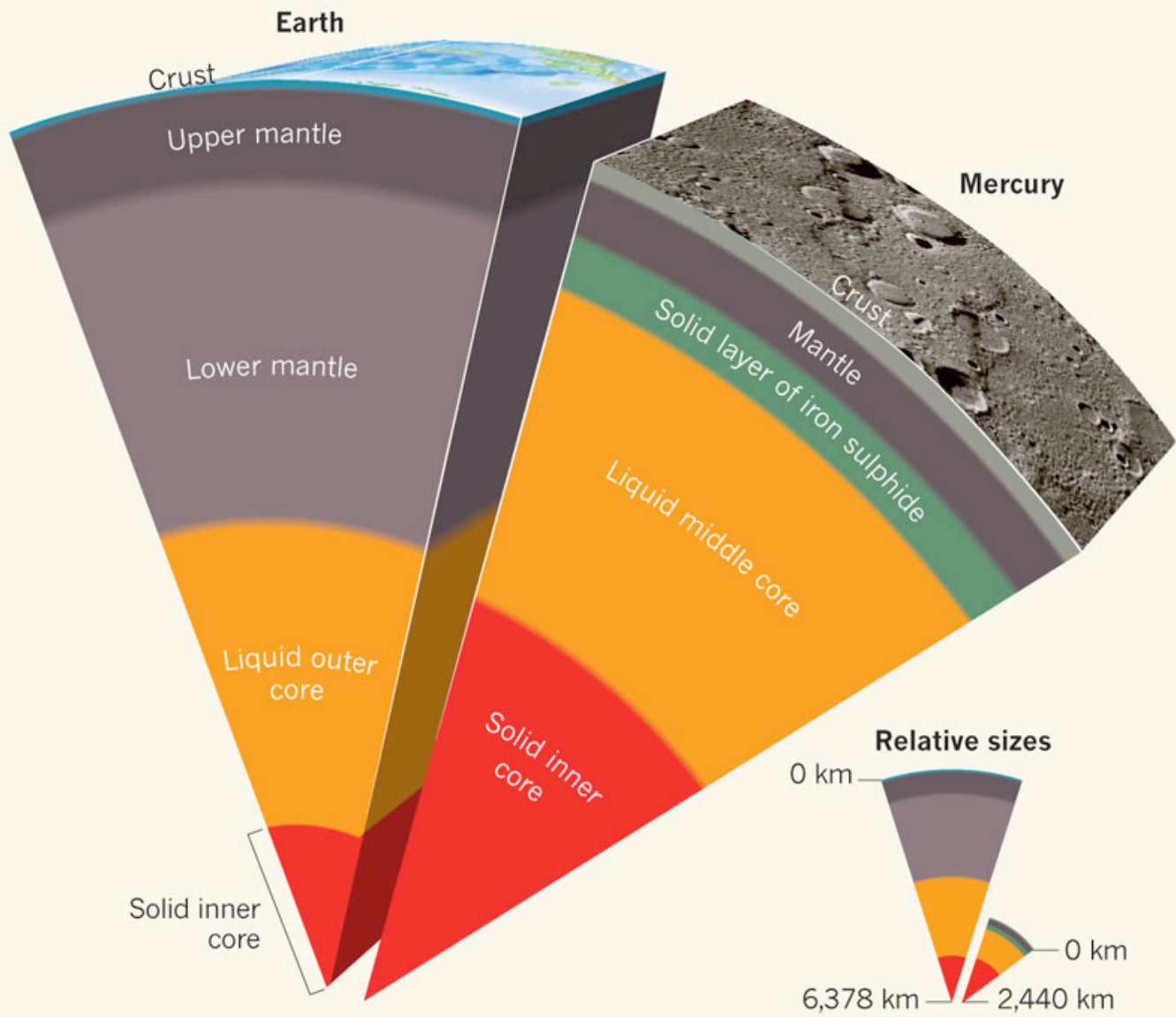

JOHNSON ET AL.: MERCURY'S MAGNETIC FIELD STRUCTURE

JGR, 2012

(a) Offset Dipole Field

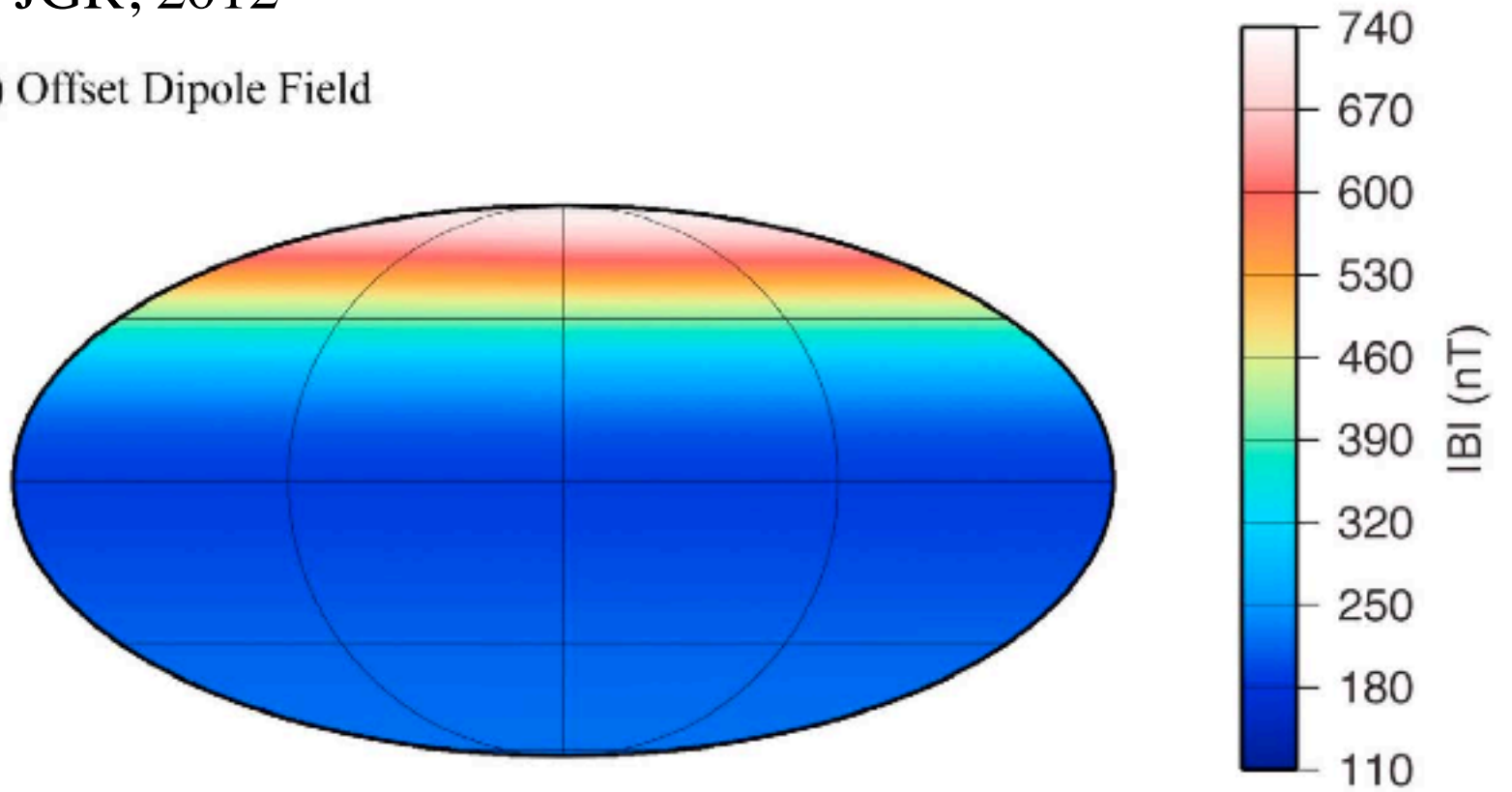

Venus

1. Earthlike structure
2. Liquid outer core likely (inferred from solar tidal gravity)
3. No magnetic field because...
 - a. No inner core because of higher T; lower P than Earth.
Or...
 - b. Planet currently heating up as it transitions from mobile to stagnant surface.
 - c. Role of “slow” rotation? (But 243 days \ll plausible convective overturn time)

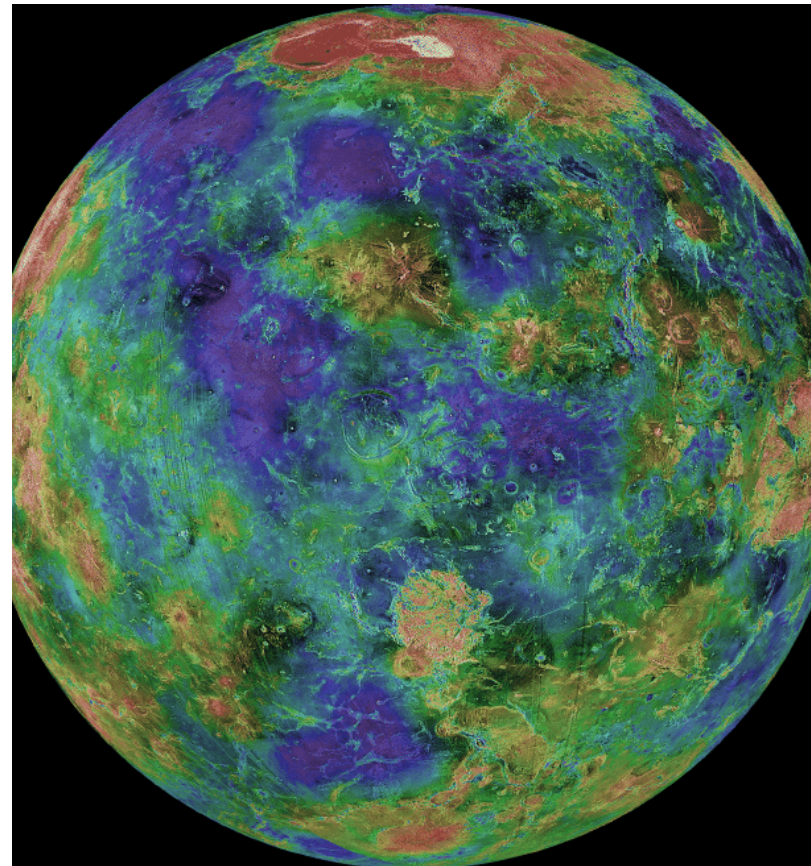

Earth

1. Field has existed for at least 3.5 Ga.
2. Energy budget is a concern. Age of inner core is not known; probably important for dynamo generation.
3. Additional energy source desirable.. ^{40}K or exsolution are possibilities

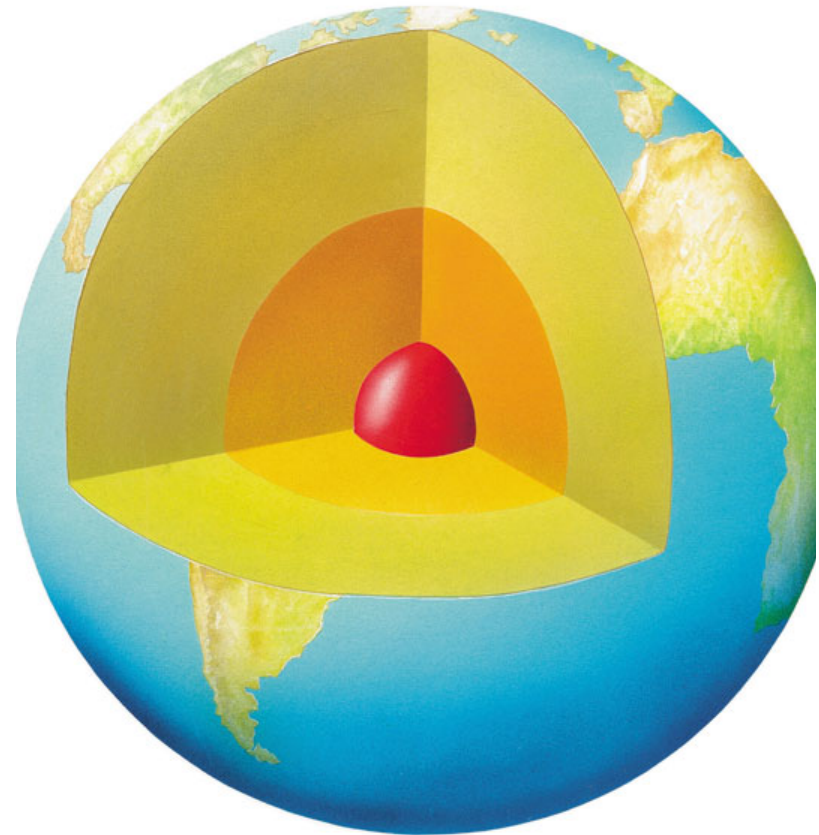

Moon

1. Small, partly liquid core suggested by response to 18.6 yr nutation. Also consistent with moment of inertia, EM induction and geochemistry.
2. No global dipole but has localized magnetization. Acquired over an extended period of time from 4.4 to ~3.9 GA bp.
3. A possible special case... mechanically driven dynamo? Or inner core

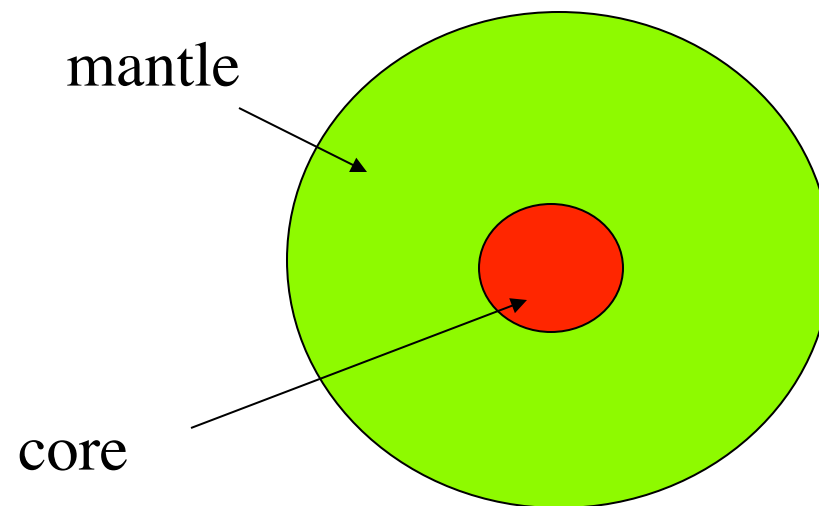
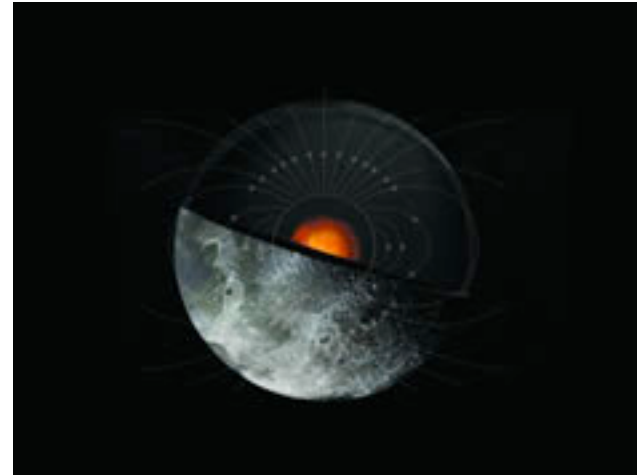

Mars Observations

Complex, ancient
crustal
magnetism.
Predates $\sim 4\text{Ga}$.
Fields reach
 $\sim 1\text{Gauss}$ at
surface? Suggests
an ancient
dynamo.

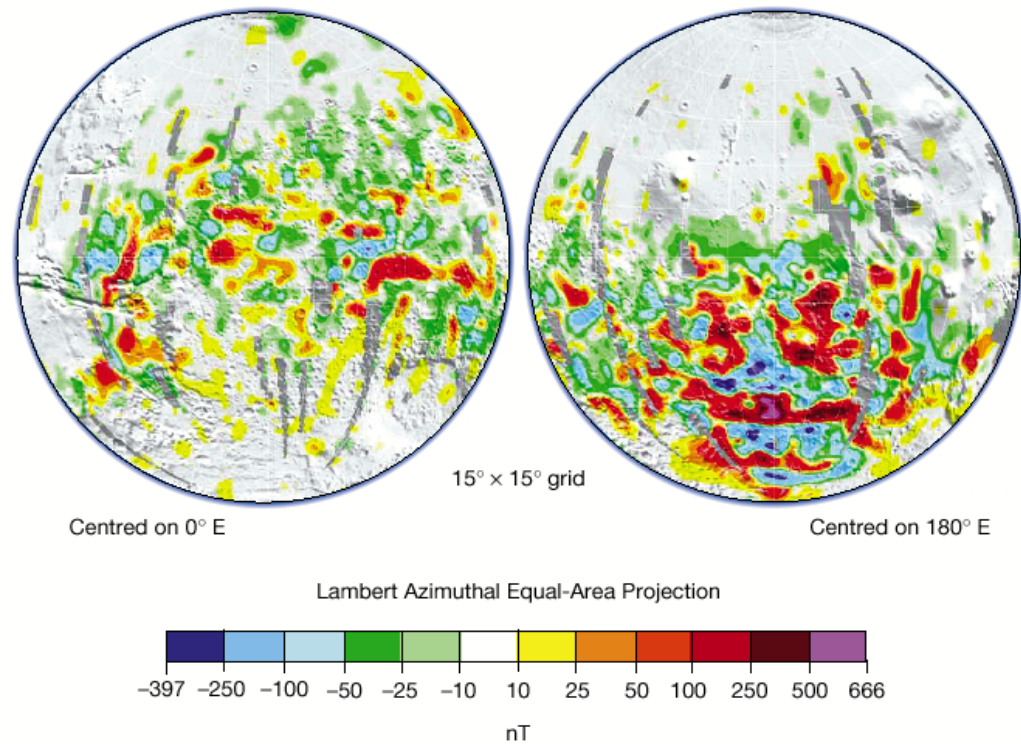

MGS measured field at 200km altitude

Mars Structure

- Earthlike core & mantle
- Liquid outer core deduced from tidal response (Yoder, 2003)
- Presence of an inner core not known.

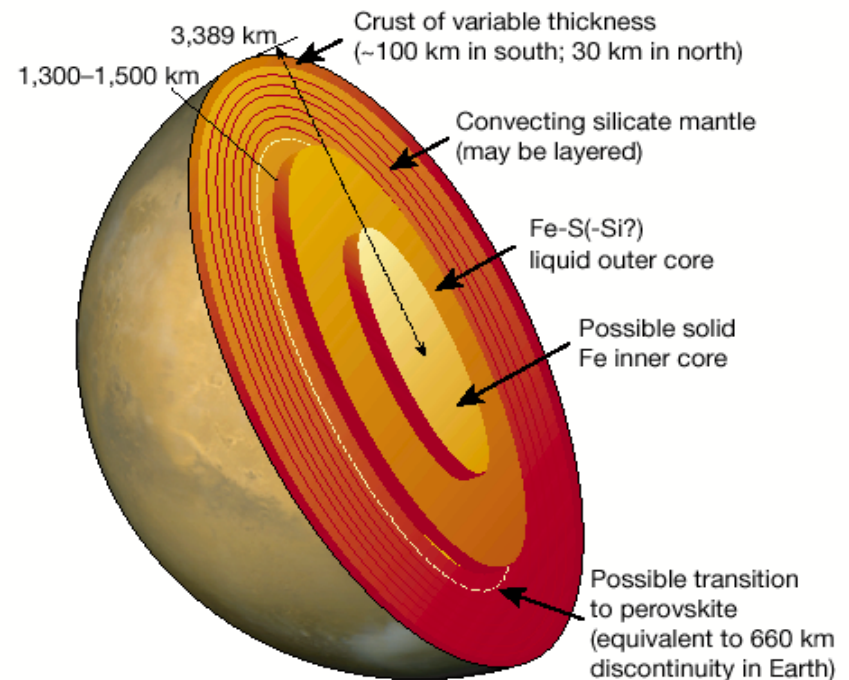

Mars Models

- **Model a:** Gradual cooling turns off core convection (no inner core forms)
- **Model b:** Outer core becomes too thin to sustain dynamo
- **Model c:** Transition from plate tectonics to stagnant lid heats up mantle, turns off core convection

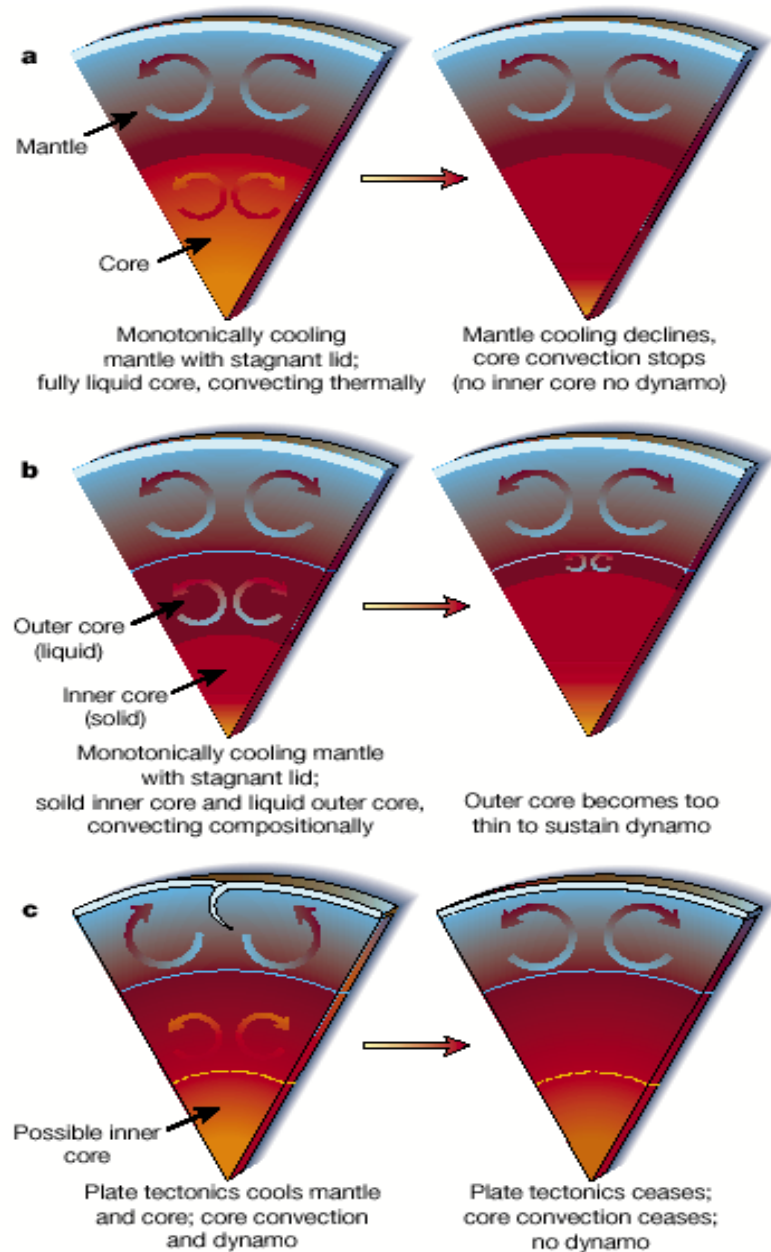

Meteorite parent bodies
may have had dynamos
(Weiss et al , 2010 & later)

High heat flow for a short
time makes this possible



Jupiter

- Approach to metallic conduction achieved in hydrogen at 0.85 Jupiter radii.
- Factor of three enrichment of heavy elements
- Presence of core not certain, but up to ~15 Earth masses

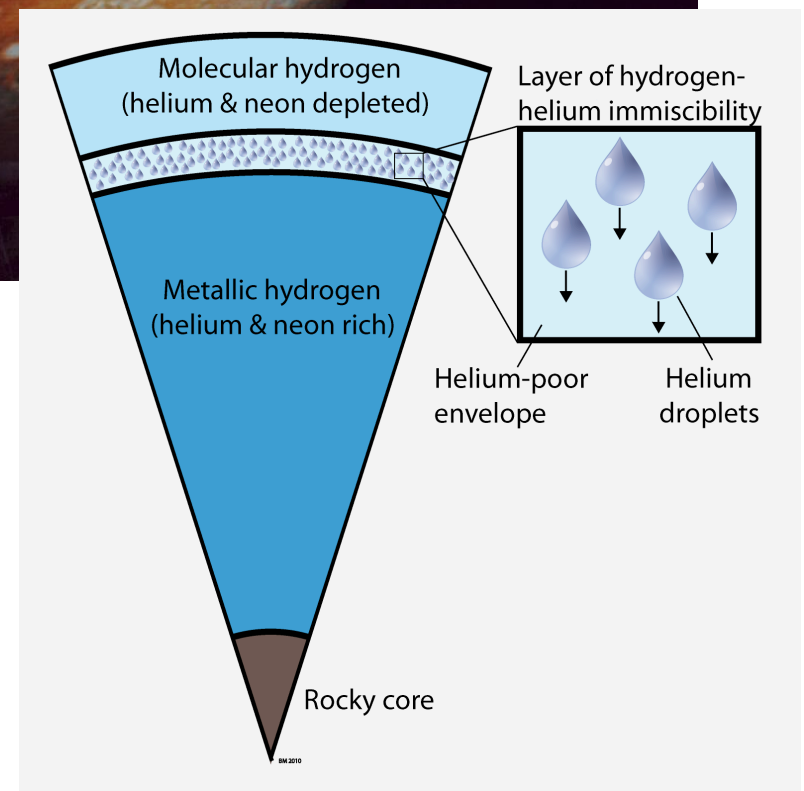

Metalization of Hydrogen

- Shock wave experiments show a rapid increase in conductivity at high P and T -approaching metallic values
- This pressure is reached at $\sim 0.85R_{\text{Jupiter}}$ or $\sim 0.55R_{\text{Saturn}}$

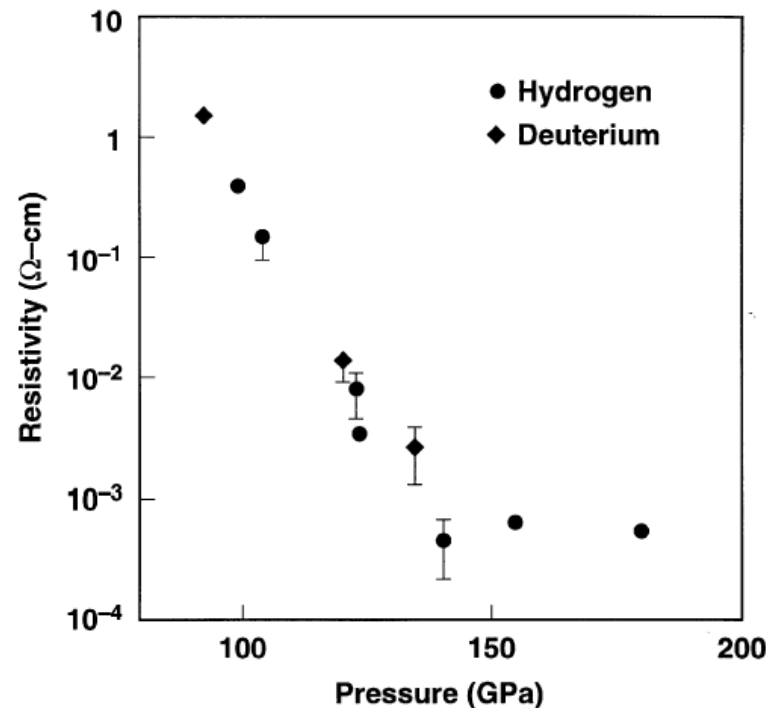
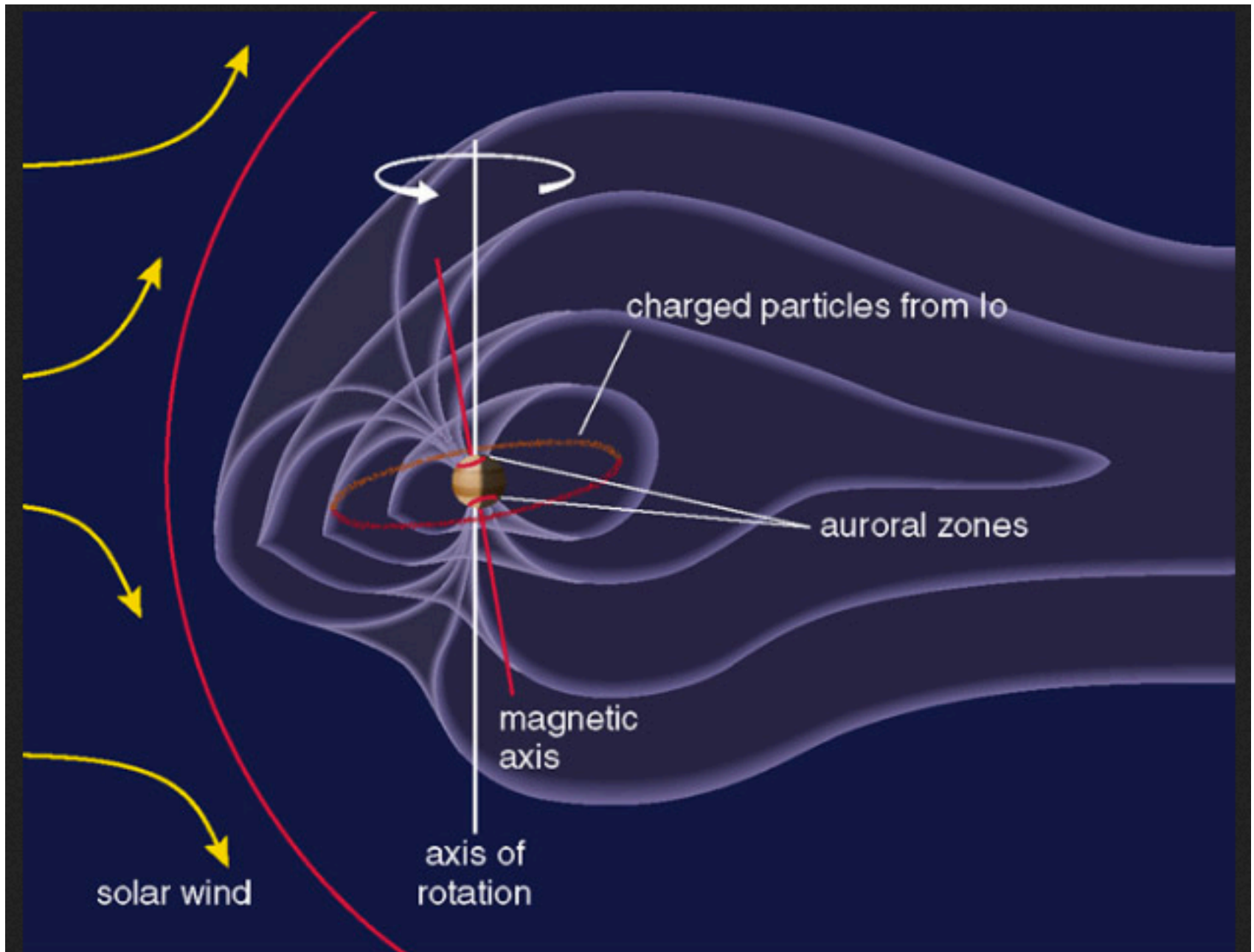

Fig. 3. Logarithm of electrical resistivity of H₂ and D₂ samples plotted versus pressure. Slope change at 140 GPa is transition from semiconducting to metallic fluid. H₂ and D₂ samples are used to obtain different final densities and temperatures

Nellis et al, 1996



Ganymede

- Metallic core, plausibly liquid if sulfur rich.
- High sulfur content lowers electrical conductivity- this may be essential!
- ^{40}K in mantle or core would also help.
- Models suggest the energy budget is only marginally satisfactory

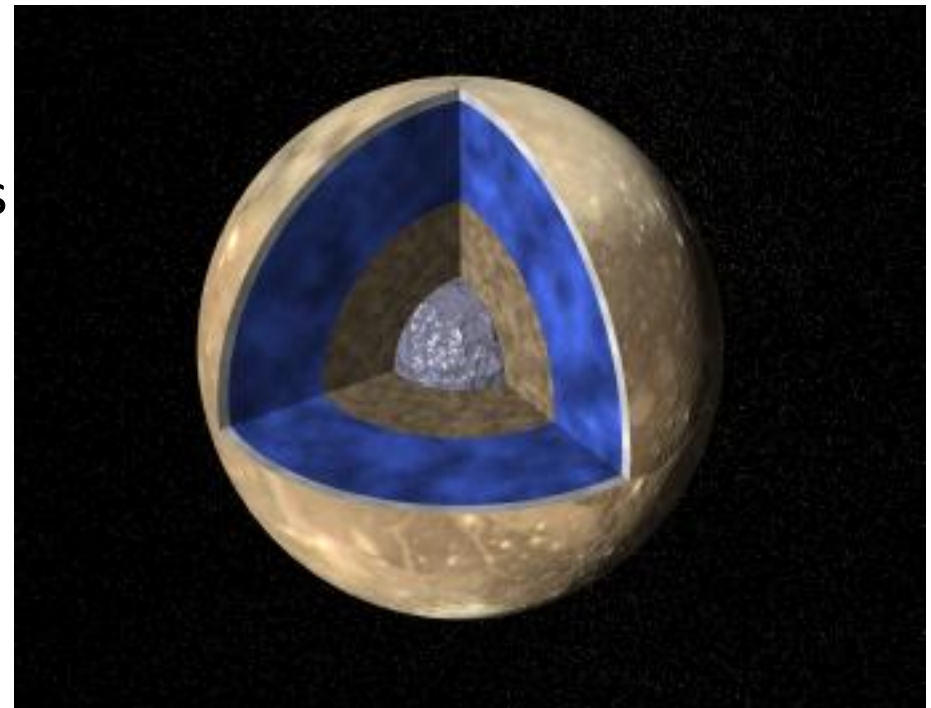

Model interior based on gravity & B field

Small Fields arising from Induction

- On *Earth* these are the well-known magnetotelluric effects
- On the *Moon* time-varying fields from the solar wind induced internal currents & fields allow inference of conductivity structure (including a possible metallic core).
- *All the Galilean satellites* are immersed in Jupiter's time-varying magnetosphere. Europa & Callisto exhibit fields that are explained by a conducting shell, most plausibly a water ocean.

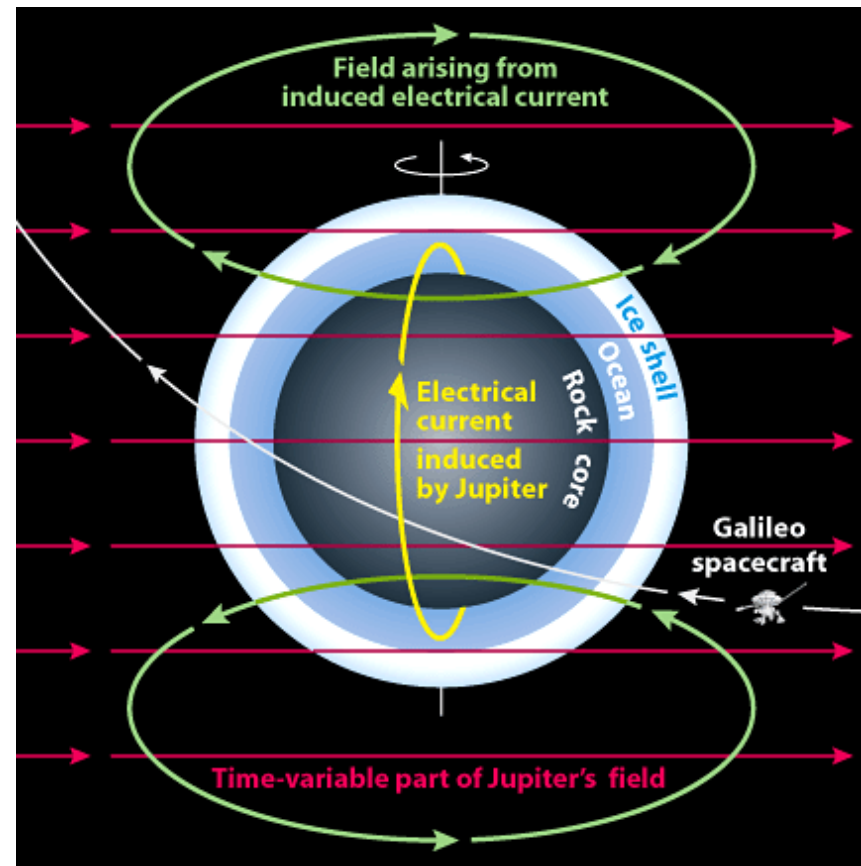

Europa ocean detection

Saturn

- Very similar to Jupiter except metallic region is much deeper.
- Very strong winds and/or helium rain may be relevant to field alignment
- Cassini will get to high latitudes?

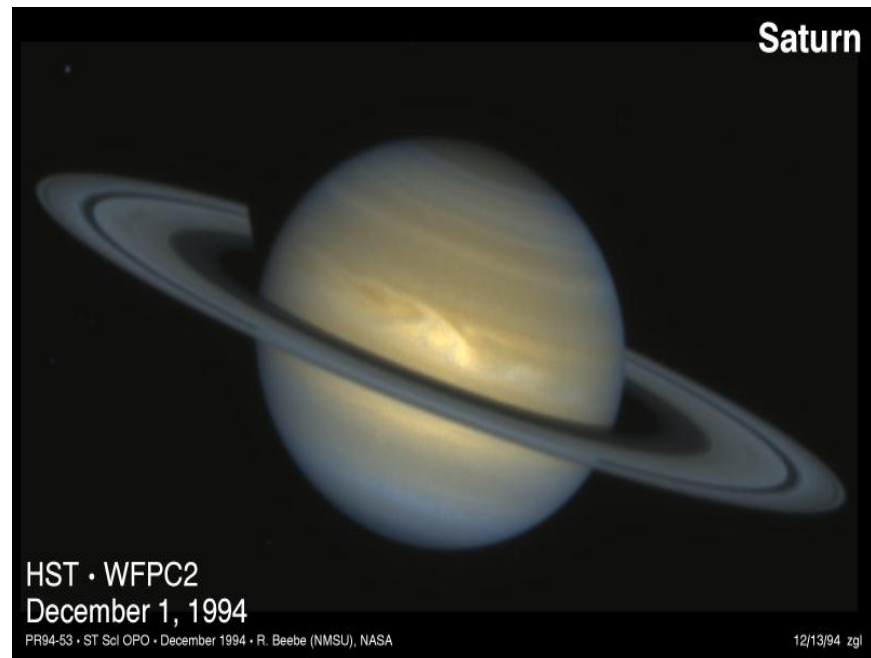

Uranus & Neptune

- Eight to ten earth masses of ice and rock; a few earth masses of gas.
- Ambiguity of structure, but gas component appears to be a nearly hydrostatic nebula add-on.
- “Metallic” conduction even at $\sim 80\%$ radius.

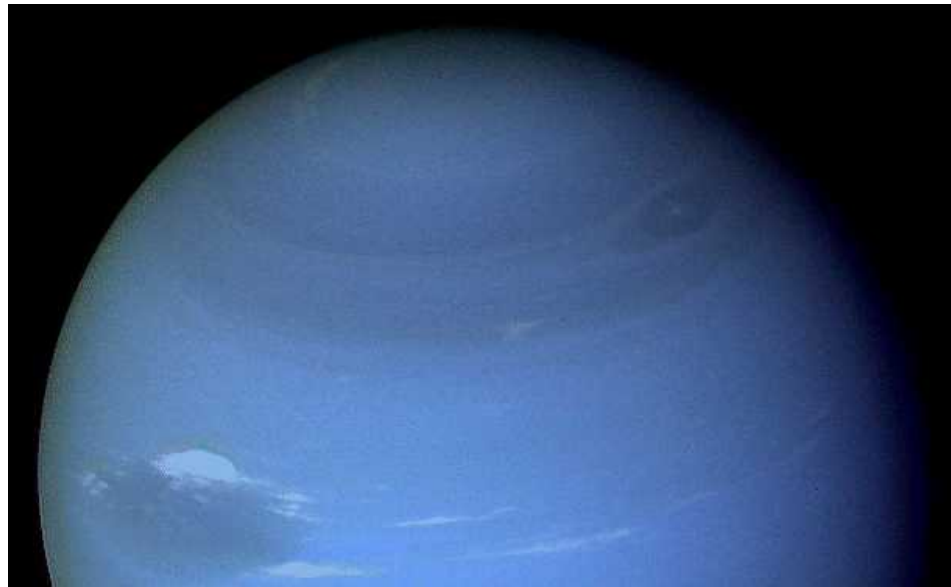

Neptune

Uranus J_2 , etc tell us that...

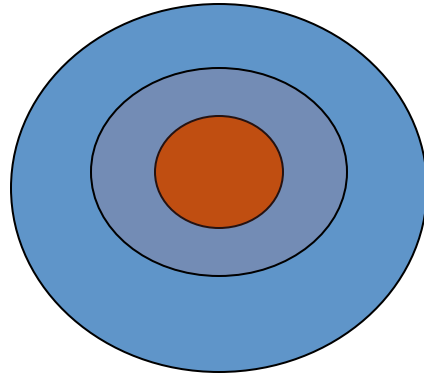

This is not Uranus
(Layercake)

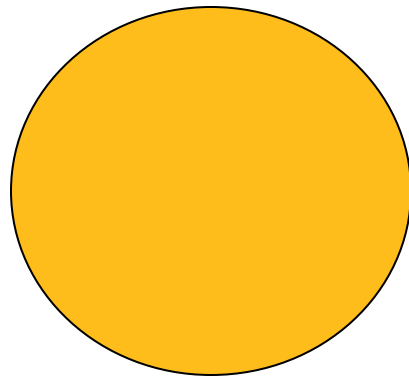

This is not Uranus
(all mixed up)

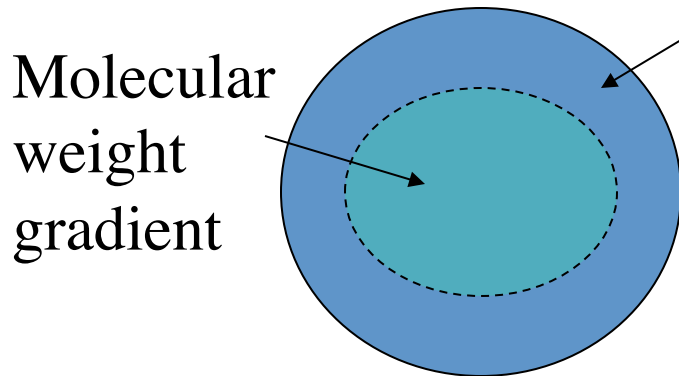

convective

Molecular
weight
gradient

This is Uranus?
(Using heat flow,
magnetic field, etc)

Field Magnitude

- Dynamo theory suggests that the Lorentz force and Coriolis force are comparable
- This suggests *Elsasser number* $\Lambda \equiv B^2 \sigma / 2\rho\Omega \sim 1$
- Actual planets satisfy only moderately well

$$\Lambda_{Earth} \sim \Lambda_{Jupiter} \sim \Lambda_{Ganymede} \sim \Lambda_{Saturn} \sim 0.3,$$

$$\Lambda_{Uranus} \sim \Lambda_{Neptune} \sim 0.1?$$

[based on fields at surface of core region]