

The Huygens Probe at Titan

Ralph D. Lorenz

ralph.lorenz@jhuapl.edu

KISS
Presentation
May 2010



ESA Huygens Project Team 1990-1991

University of Kent (SSP) 1991-1994

University of Arizona 1994-2006

JHU Applied Physics Lab 2006-

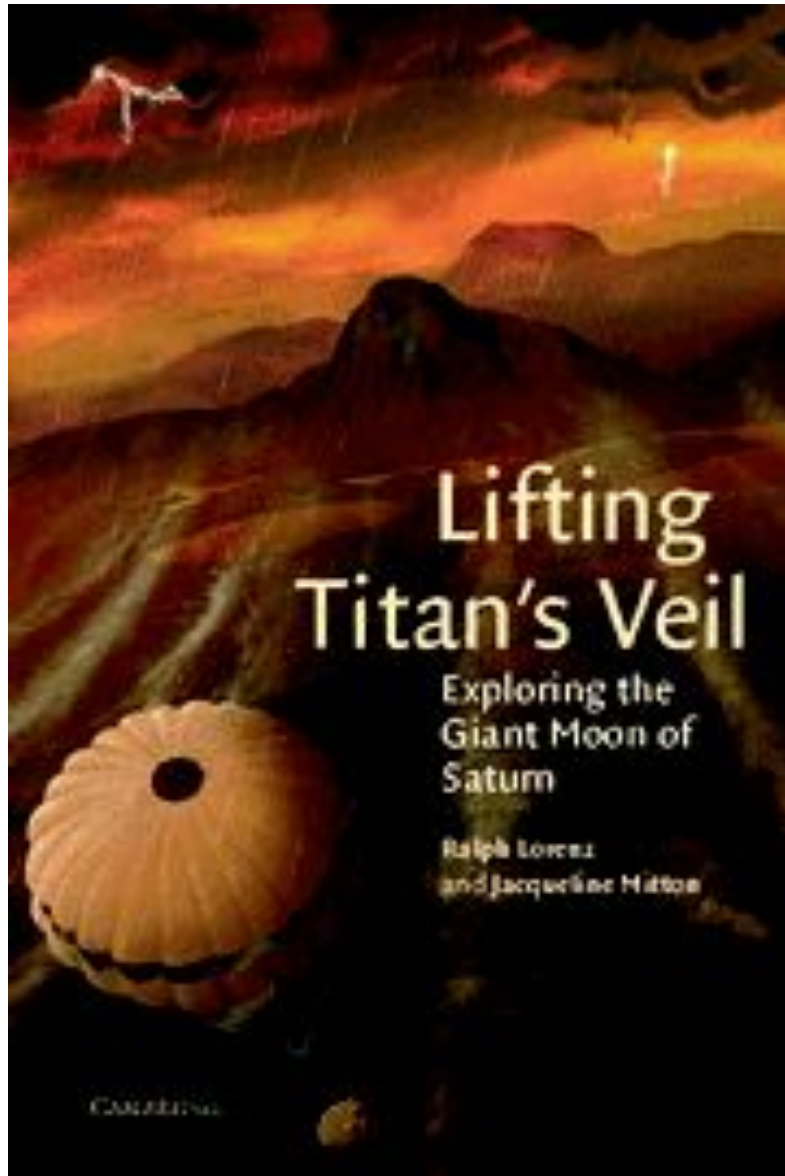

CUP, 2002

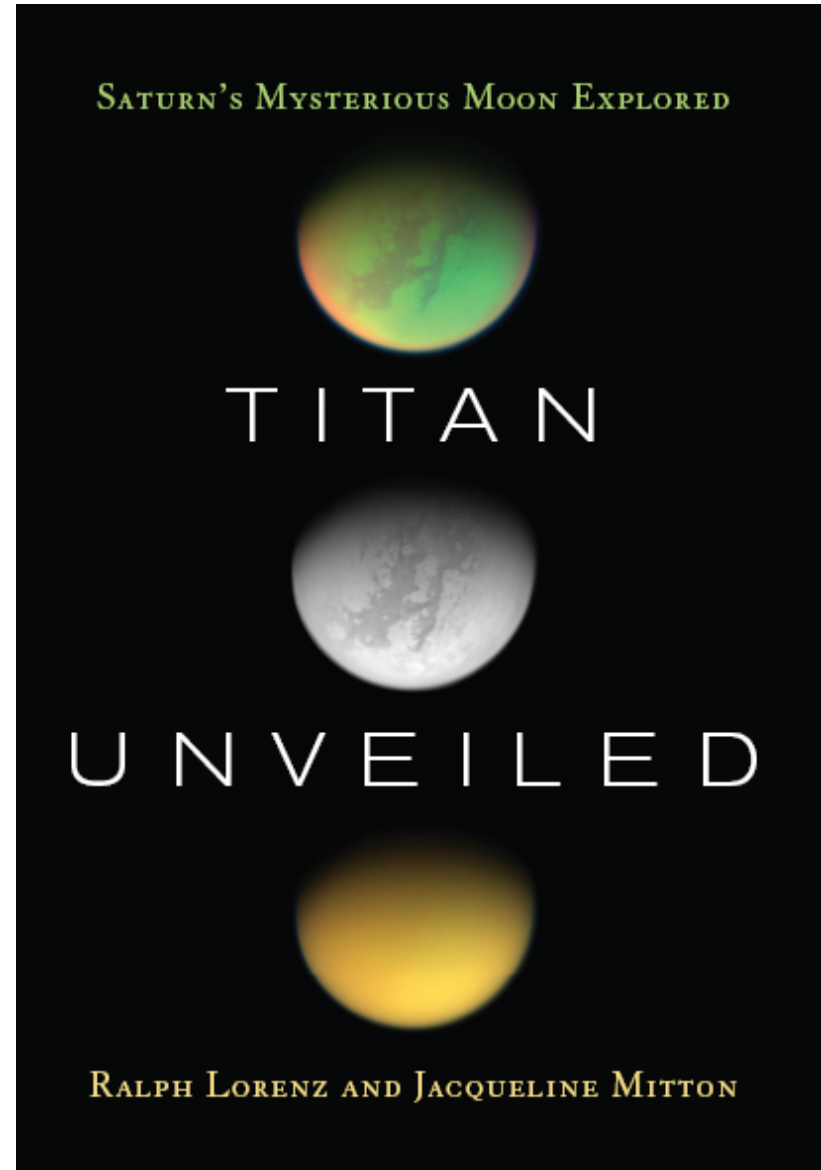

PUP, 2008
Revised paperback 2010

The background of the slide is a reddish-orange landscape, likely representing the surface of Titan. In the foreground, there is a dark, rippling body of liquid. In the middle ground, there are low, rounded hills. In the sky, a large, dark, dome-shaped parachute is suspended by several lines, with a small, dark object hanging from it. The overall color palette is dominated by shades of red, orange, and brown.

Outline

**Huygens Project
Probe Design**

Descent Dynamics and Spin

Impact

Thermal Behaviour

(RF multipath ; Receiver Anomaly and Resolution)

Cassini Spacecraft

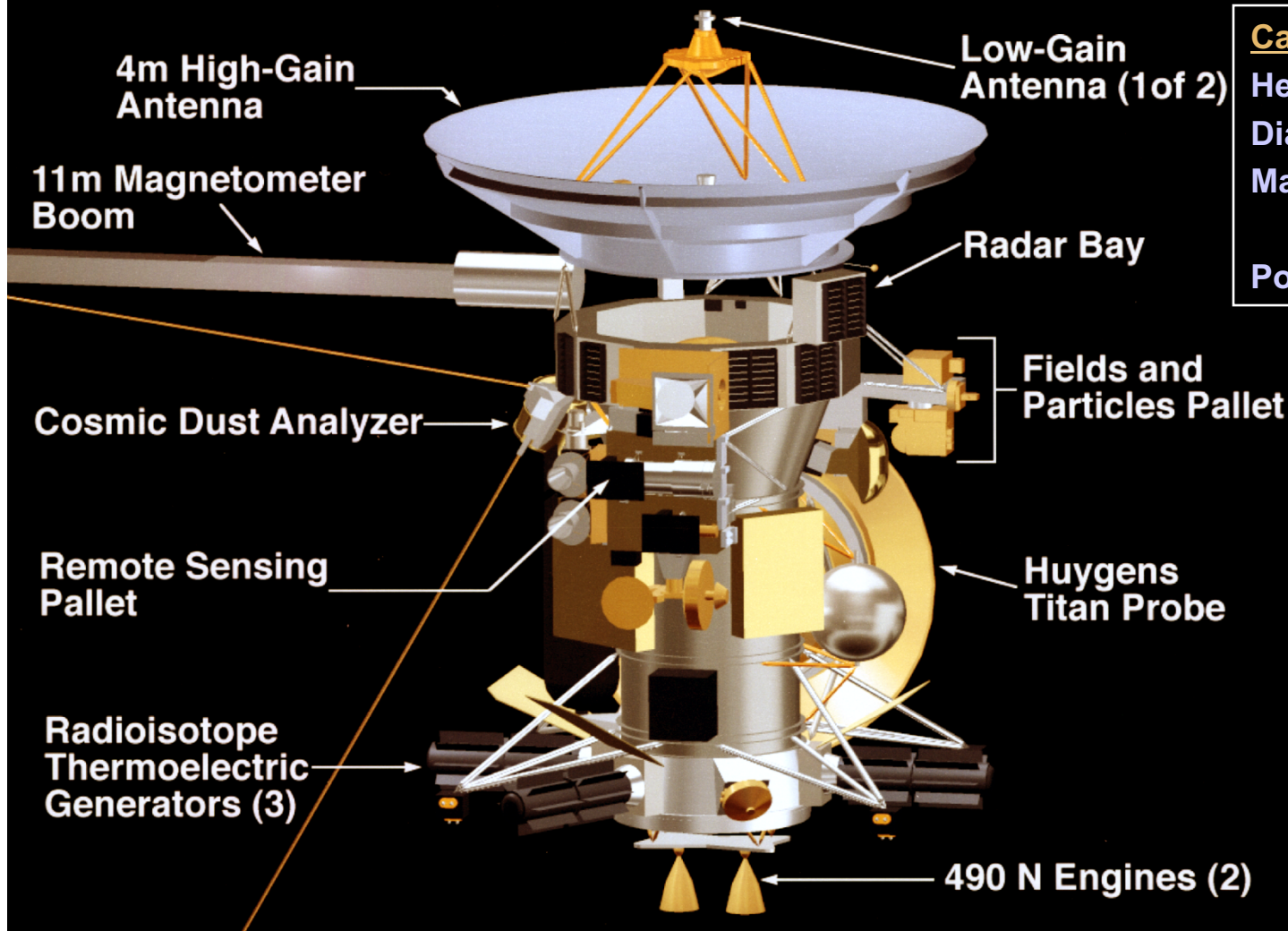

Cassini Spacecraft Specs

Height: 6.8 m (22 ft)

Diameter: 4 m (13 ft)

Mass: 2500 kg (2.8 tons)

(fueled): 5600 kg (6 tons)

Power: 700 Watts at SOI

Huygens Probe Specs

Diameter: 2.7 m

Mass: 320kg inc. Heat shield. ~200kg at landing

~1500 W-hr Lithium primary battery

2 S-band telemetry links @ 8kbps

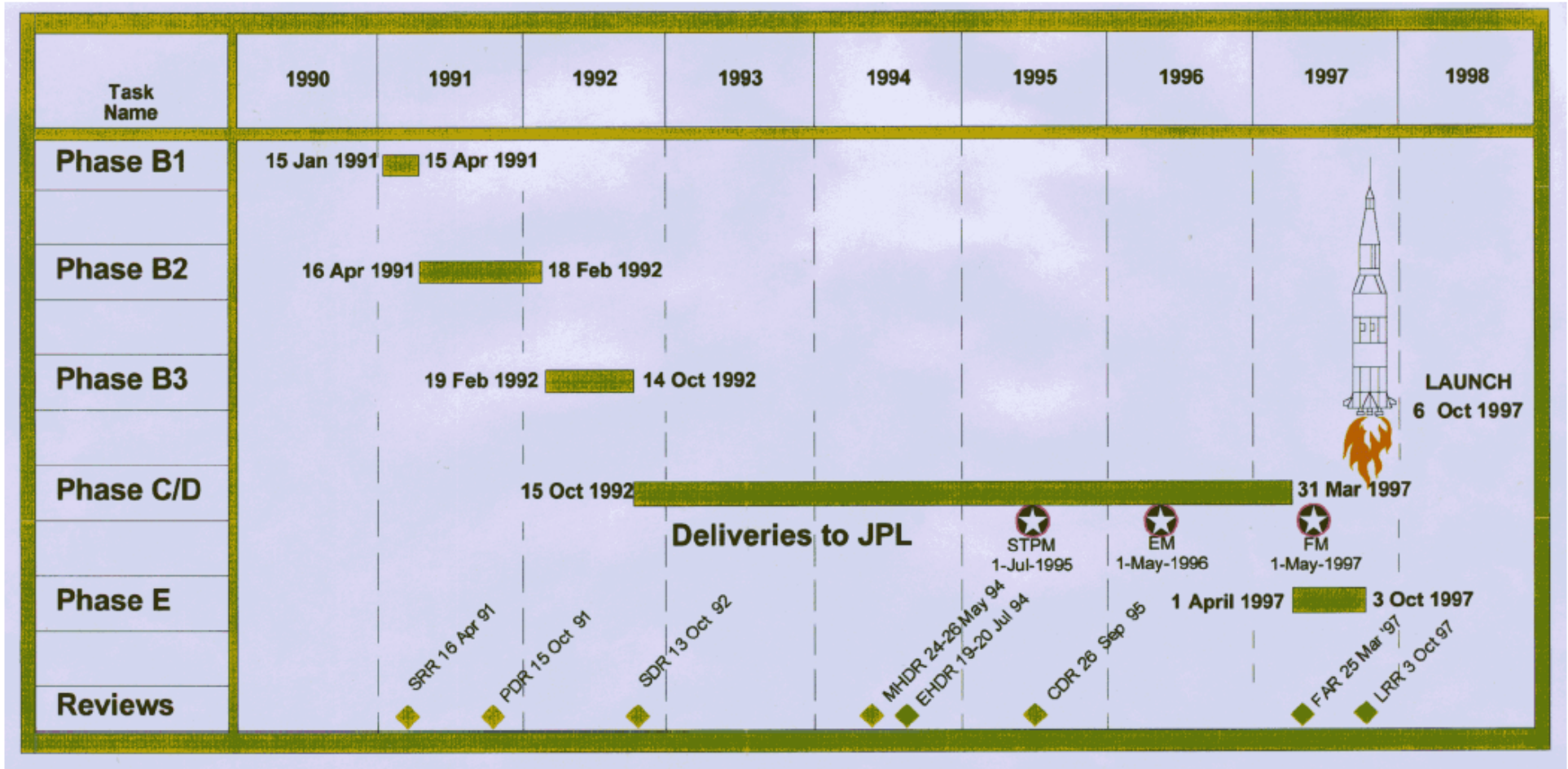

~6.5 year development schedule (NB pacing re: orbiter)

7 year flight time. Implications for knowledge retention, software/hardware maintenance.

NB change in working methods/tools (electronic documents etc.)



ESA 'juste retour' system for geographical allocation of contracts in proportion to overall budget contribution.

Institutionally essential, perhaps, but programmatically inefficient.

NB Payloads on ESA missions paid for by member states.

Huygens Probe Descent

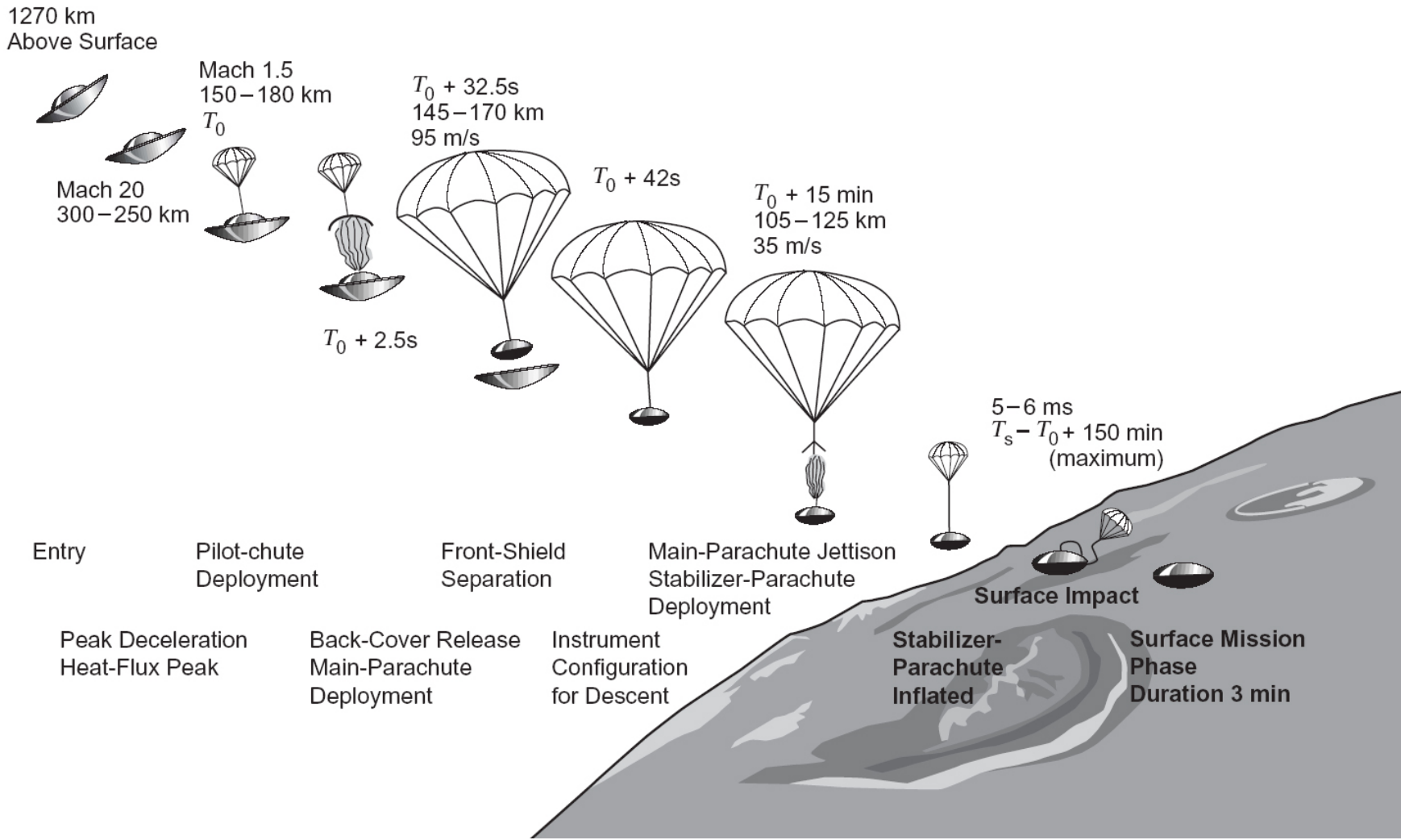



**SM2 - Parachute drop test from 40km balloon over northern Sweden, 1995
Successfully demonstrated heat shield separation/parachute sequence.
Deviant rotational behavior not noticed at the time.**

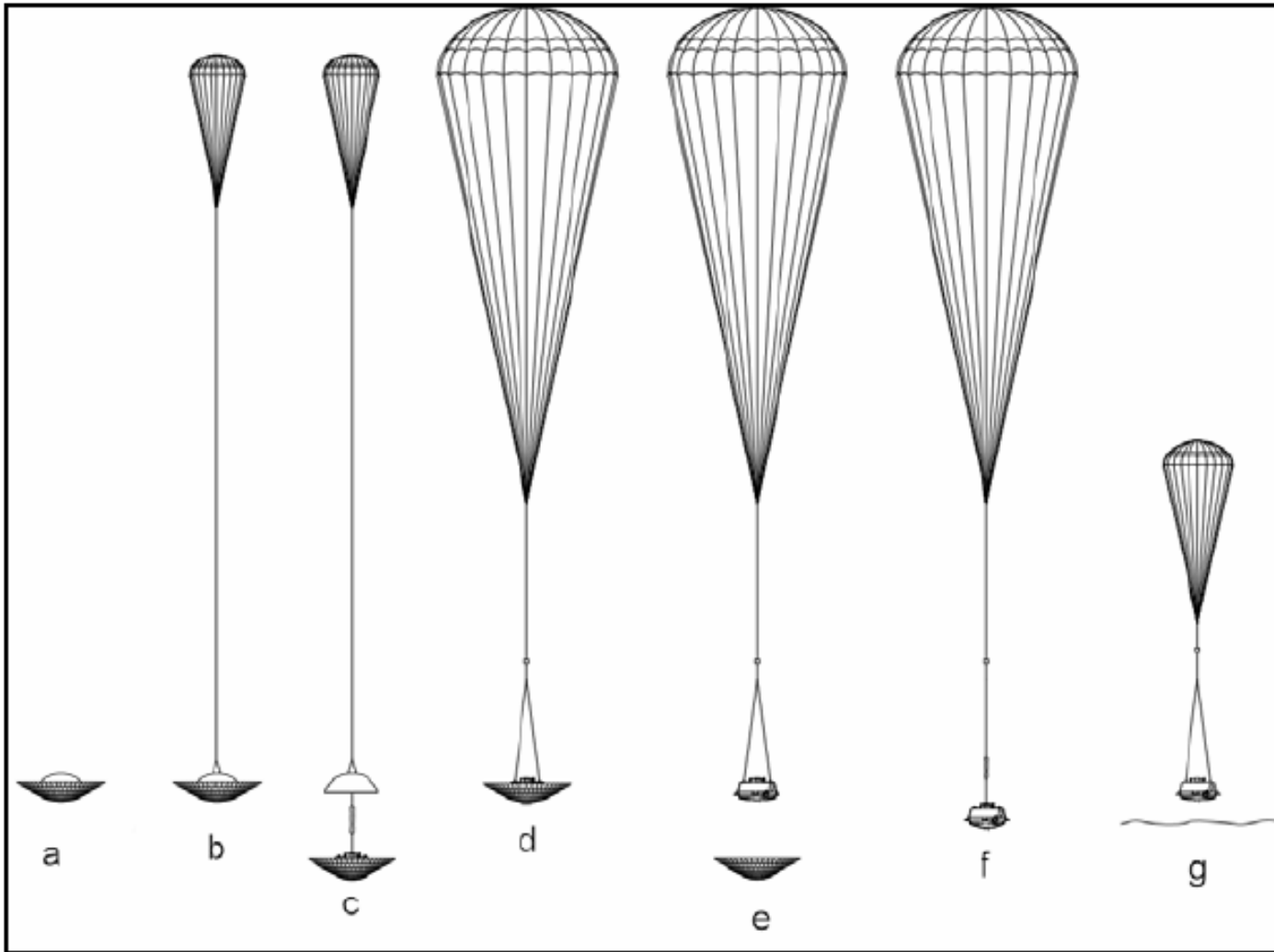

2.59m Pilot chute for transonic stability deployed by mortar through break-out patch.

Pulls off back cover and deploys main chute via lanyard. 8.3m main chute needed for safe front shield separation

3.3m Stabilising drogue to achieve descent fast enough to reach surface within telecom & energy window

All parachutes nylon DGB with kevlar bridle, riser & lines

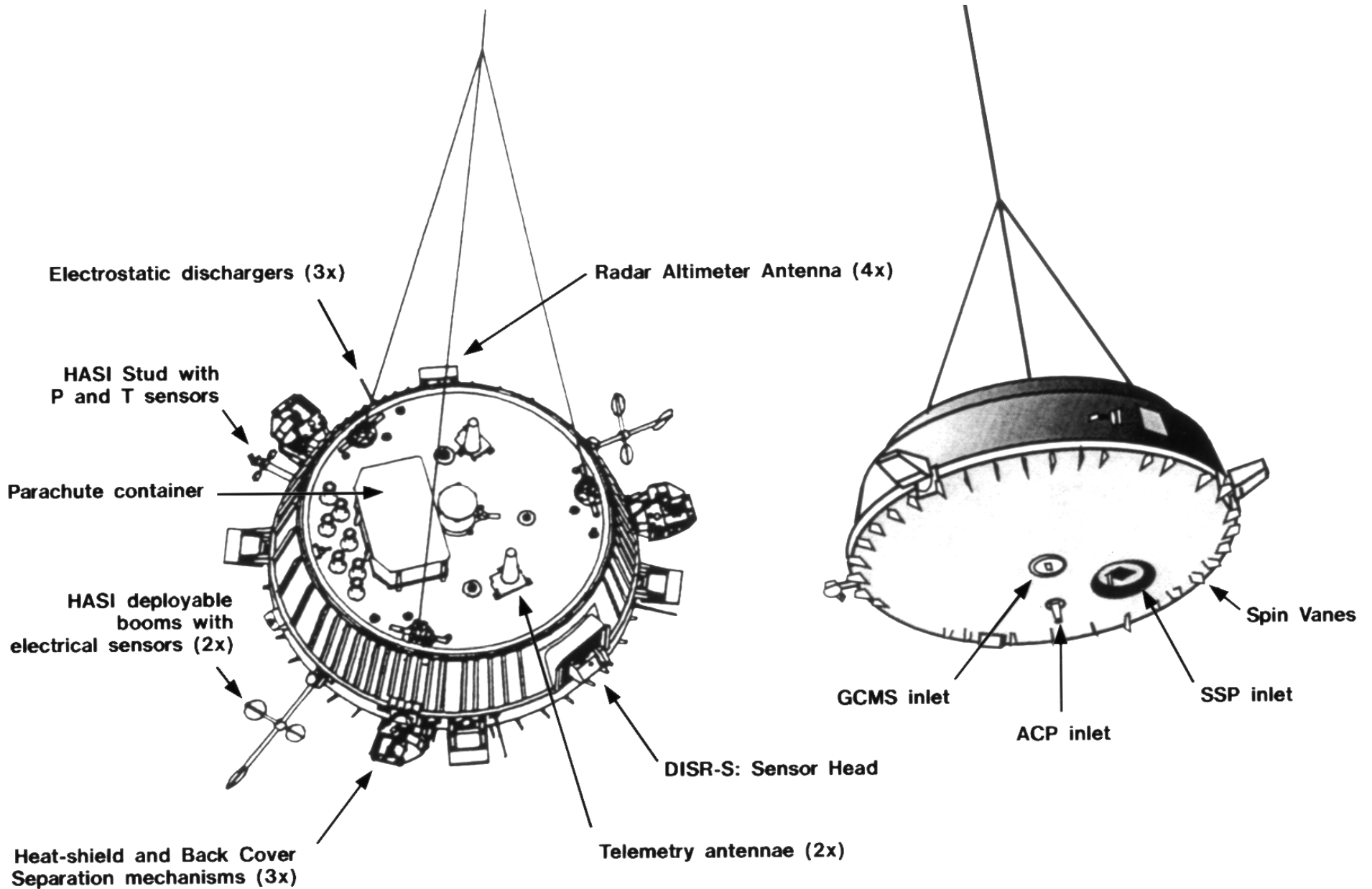

Huygens Descent Configuration

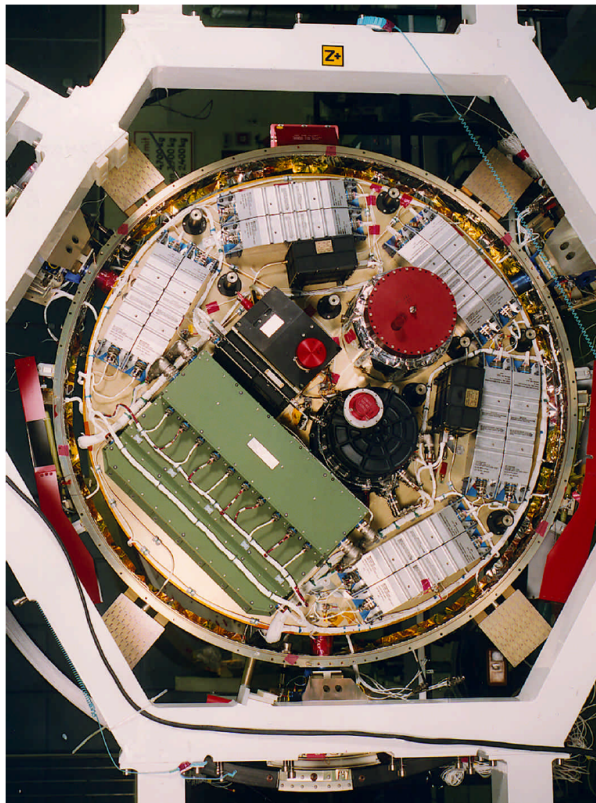
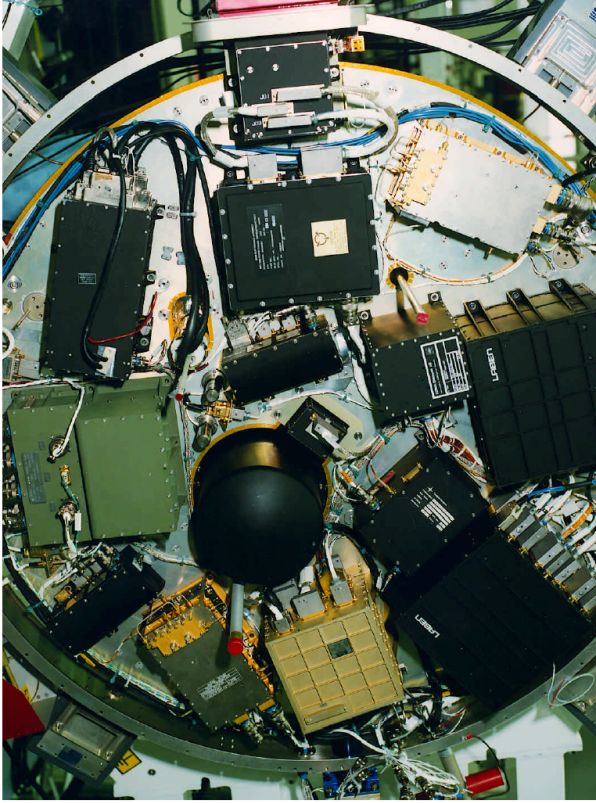

Layout of systems and payload on 1.2m 'experiment platform'

Thin metal shell acts as Faraday cage ; foam insulation.

Impact not a driver for structural design

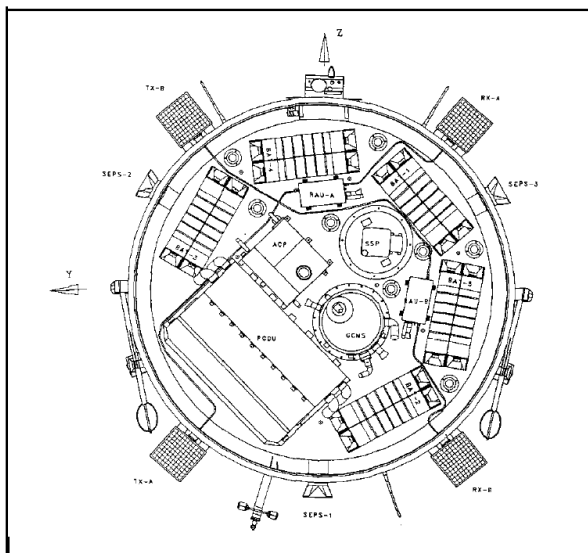
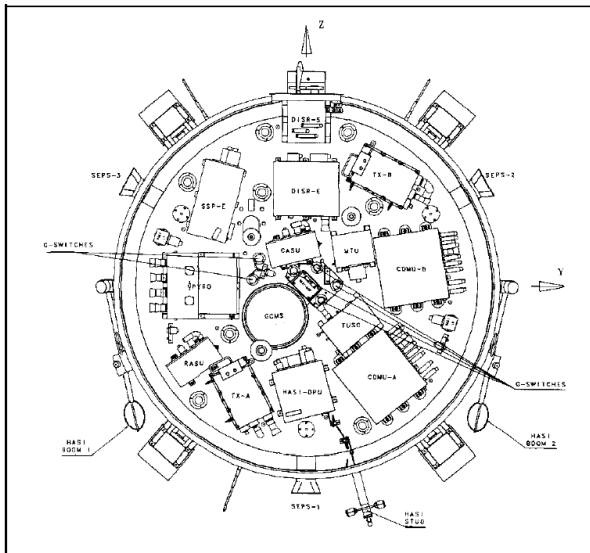

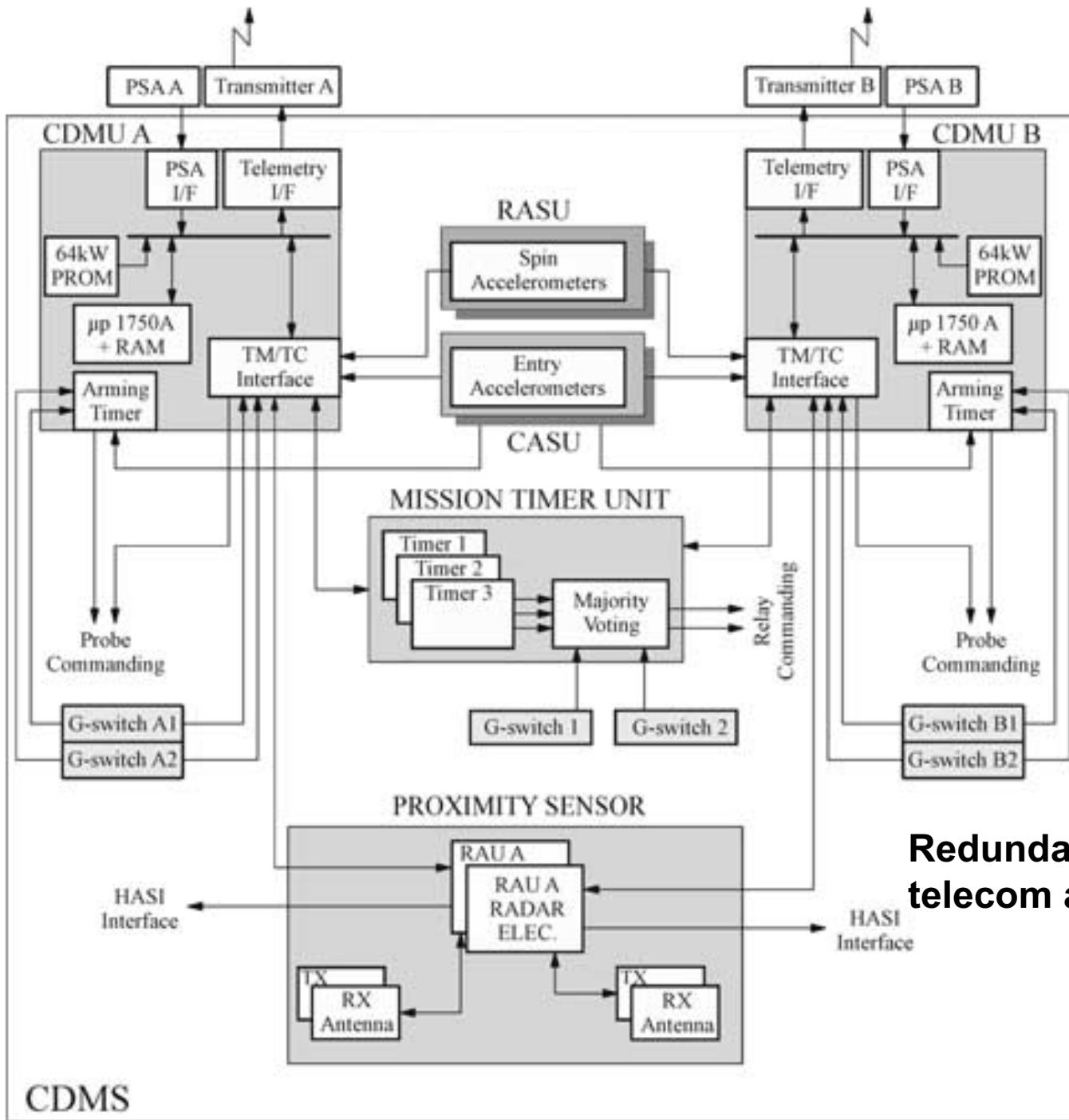

Redundant CDMMS and telecom architecture.

CDMS

Launched on October 15, 1997 from KSC

7 Year cruise on VVEJGA trajectory

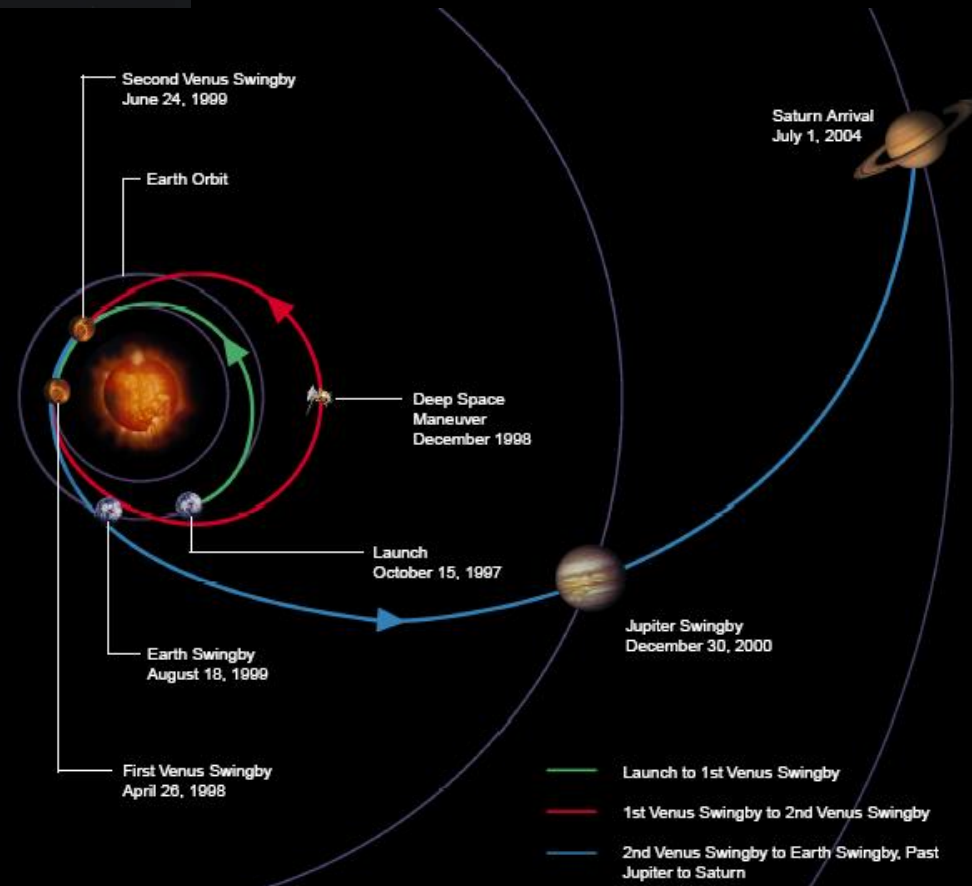

Cassini Saturn Approach through Huygens Probe Mission

Early orbit sequence and delivery modified after radio flaw discovered in 1999

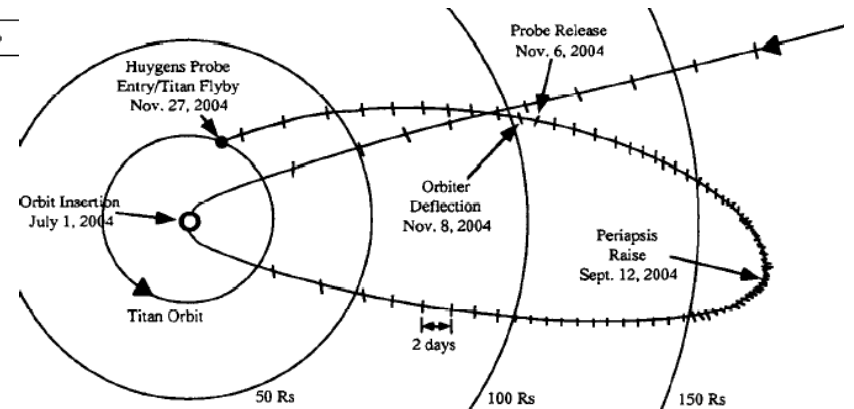
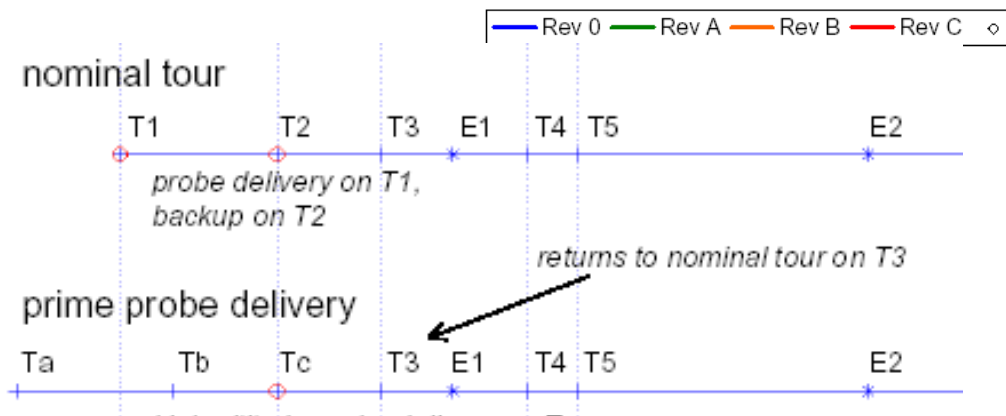
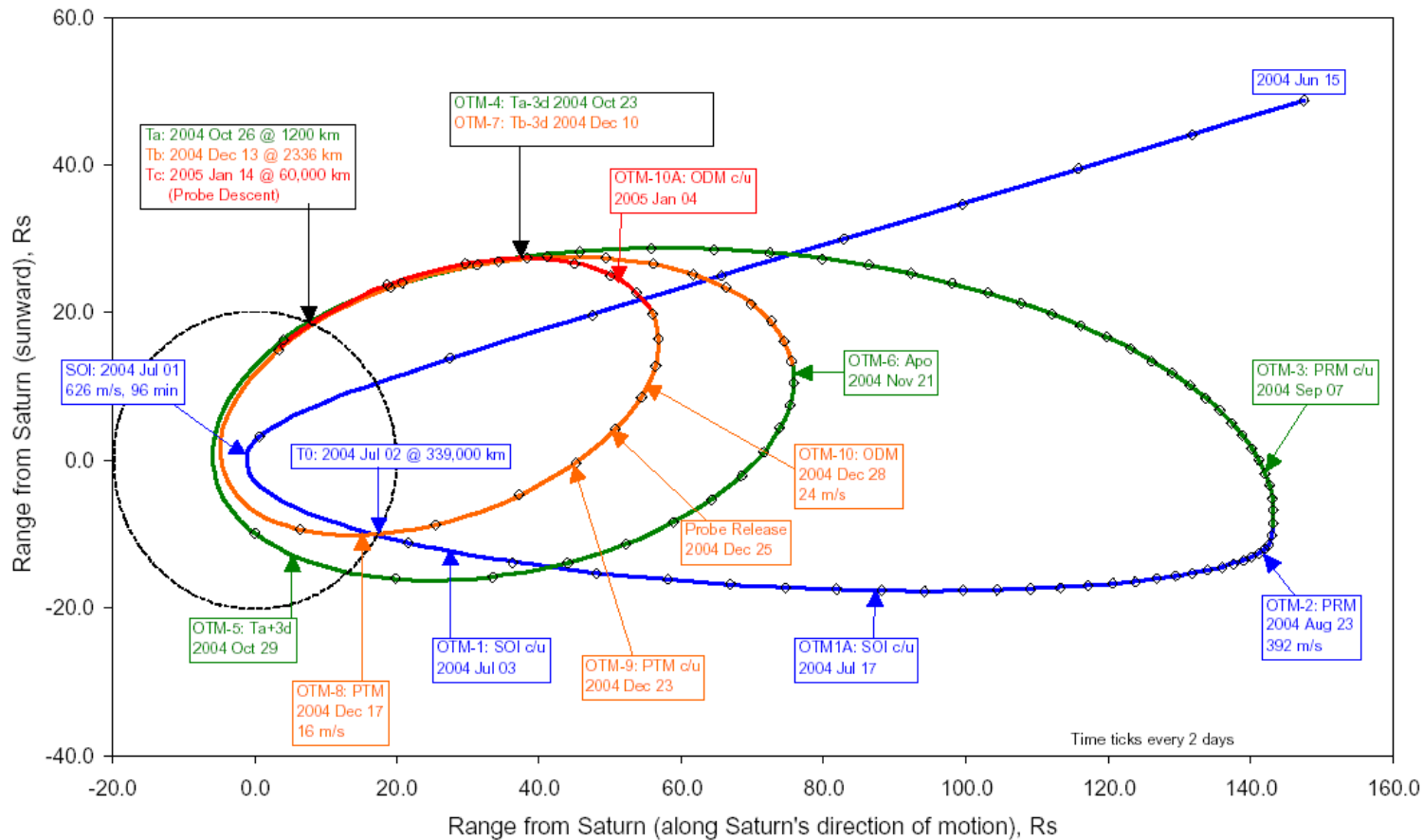

Separation Performed Dec 24, 2004

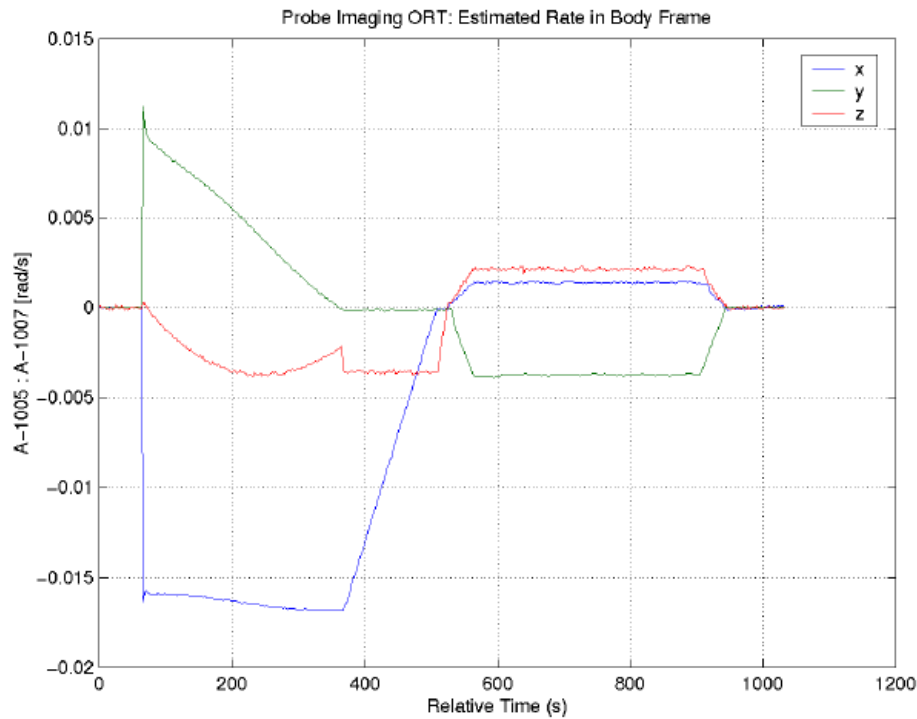

**Huygens from
52km away
(Dec 26, 2004)**

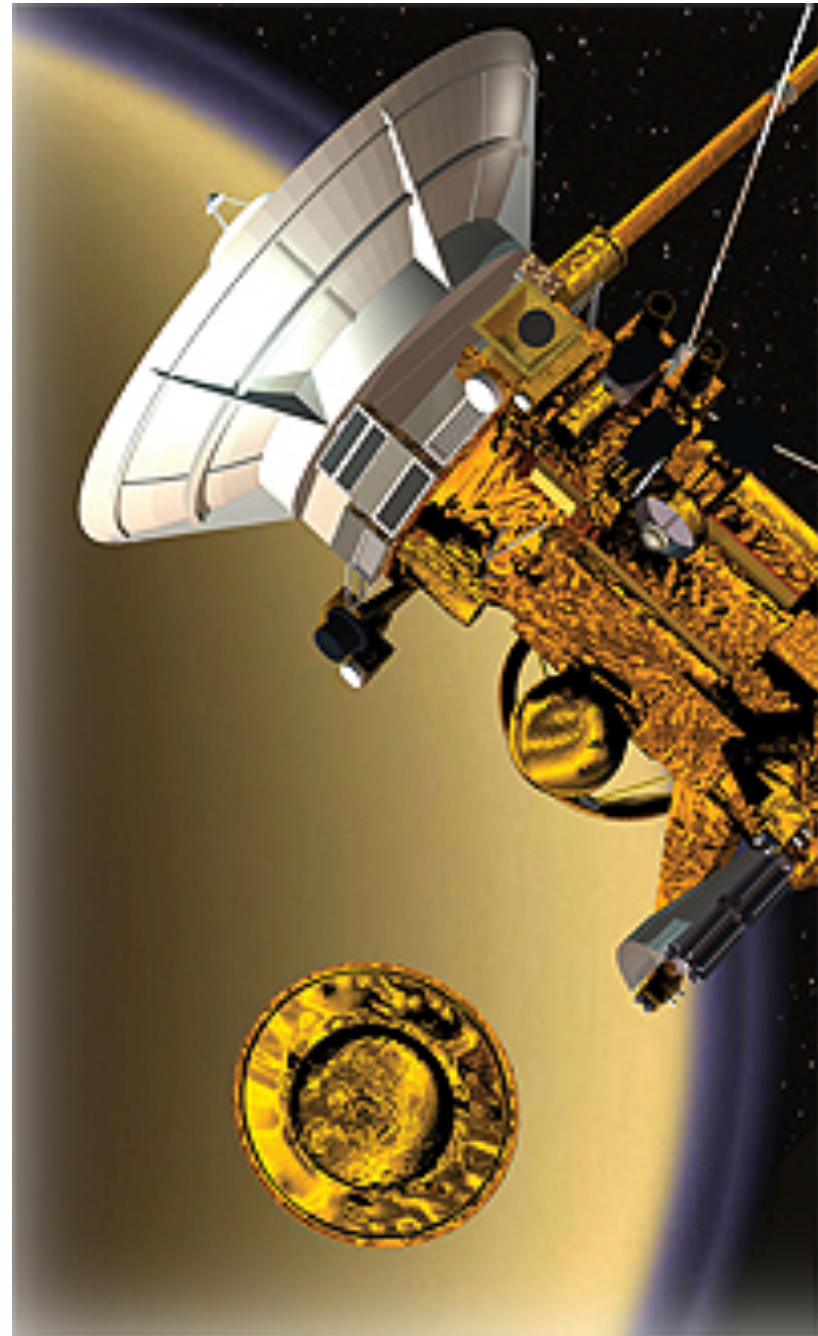
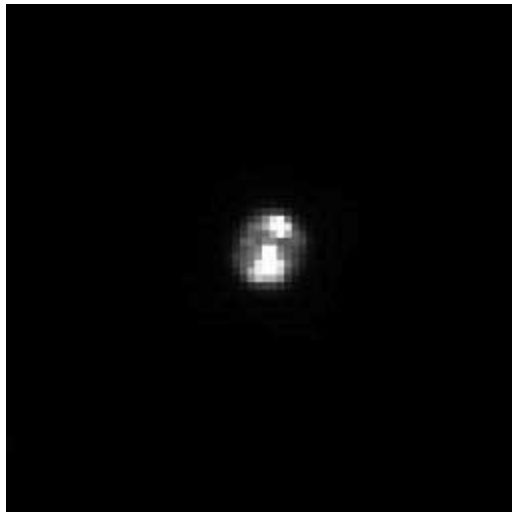

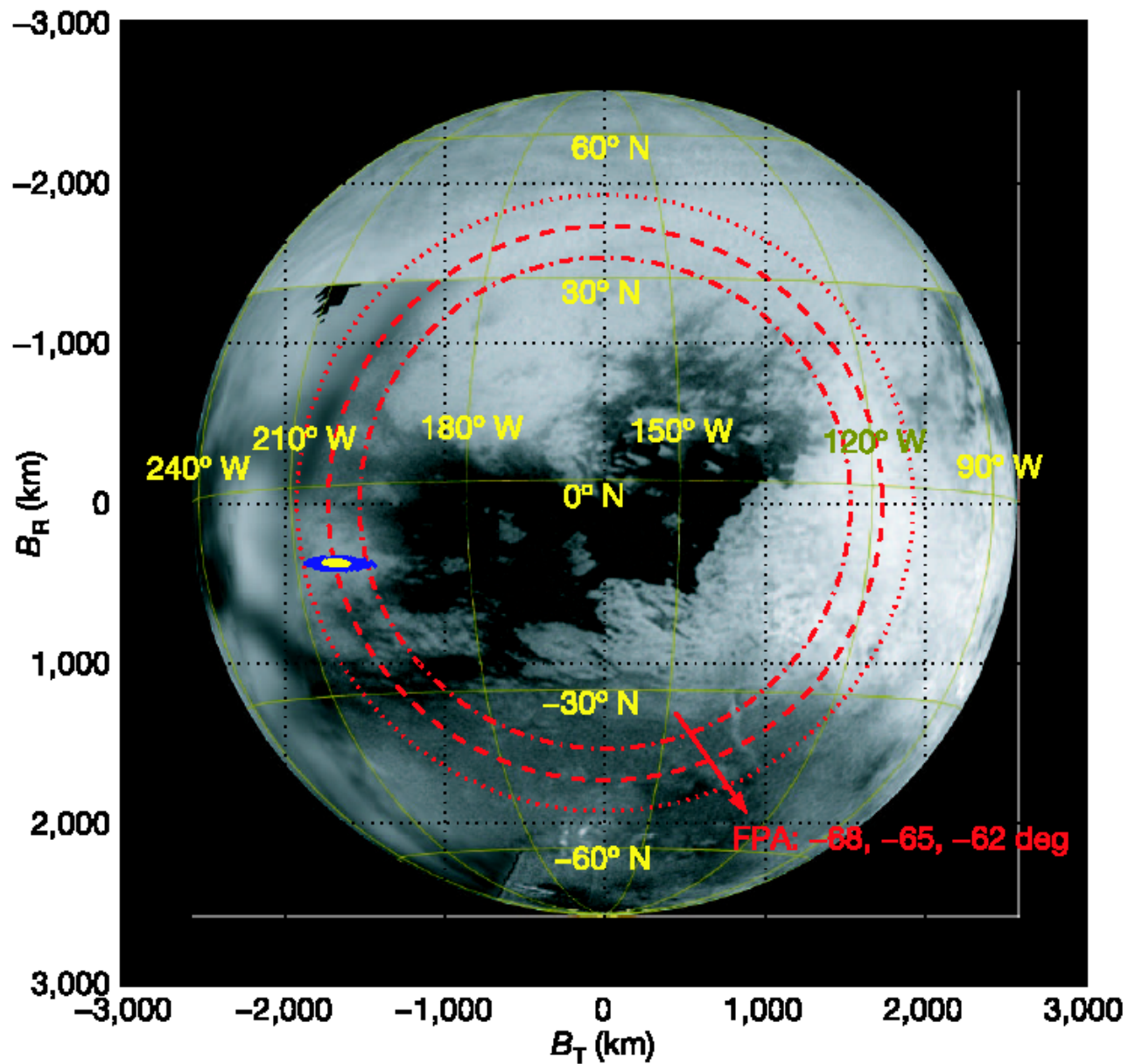

Landing site chosen largely by geometric constraints (entry angle, solar zenith, doppler wind projection)

Earth as seen by Huygens: 2005.01.14, 10:19 UTC

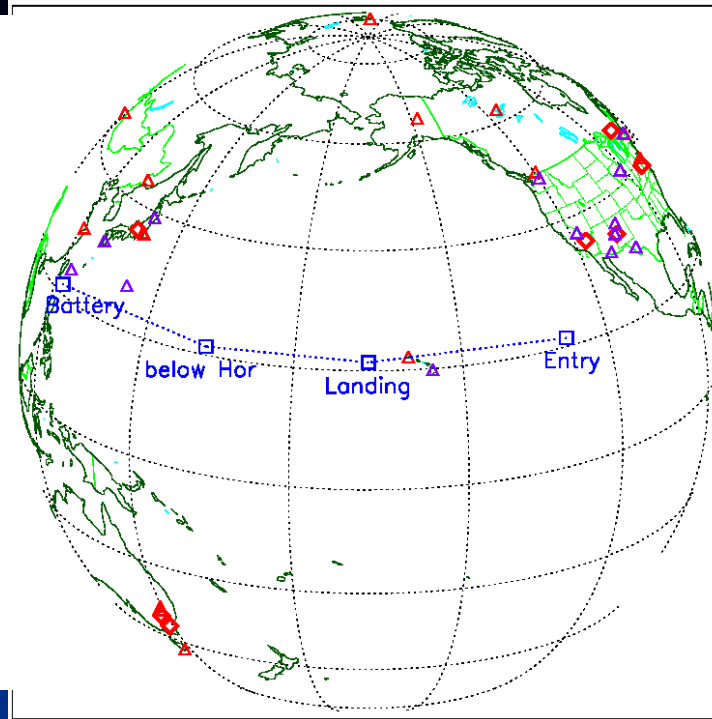
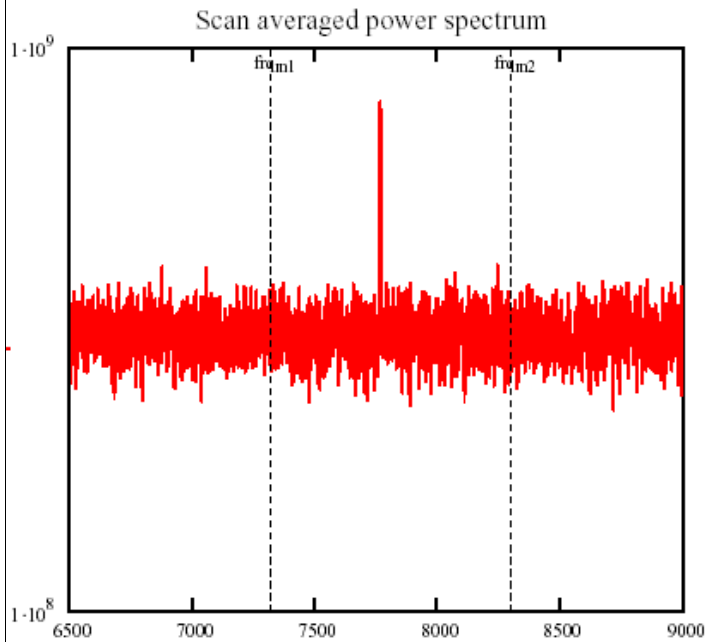

First detection by Green Bank ; Parkes took over. Supplemented by smaller telescopes (e.g. Kitt Peak) Probe probably transmitted for >15 minutes after last detection.

NB two distinct observing campaigns (same dishes, different receivers)

1. Real-time doppler (intended as supplement to Cassini on-board doppler recovery)
2. VLBI to monitor position on the sky

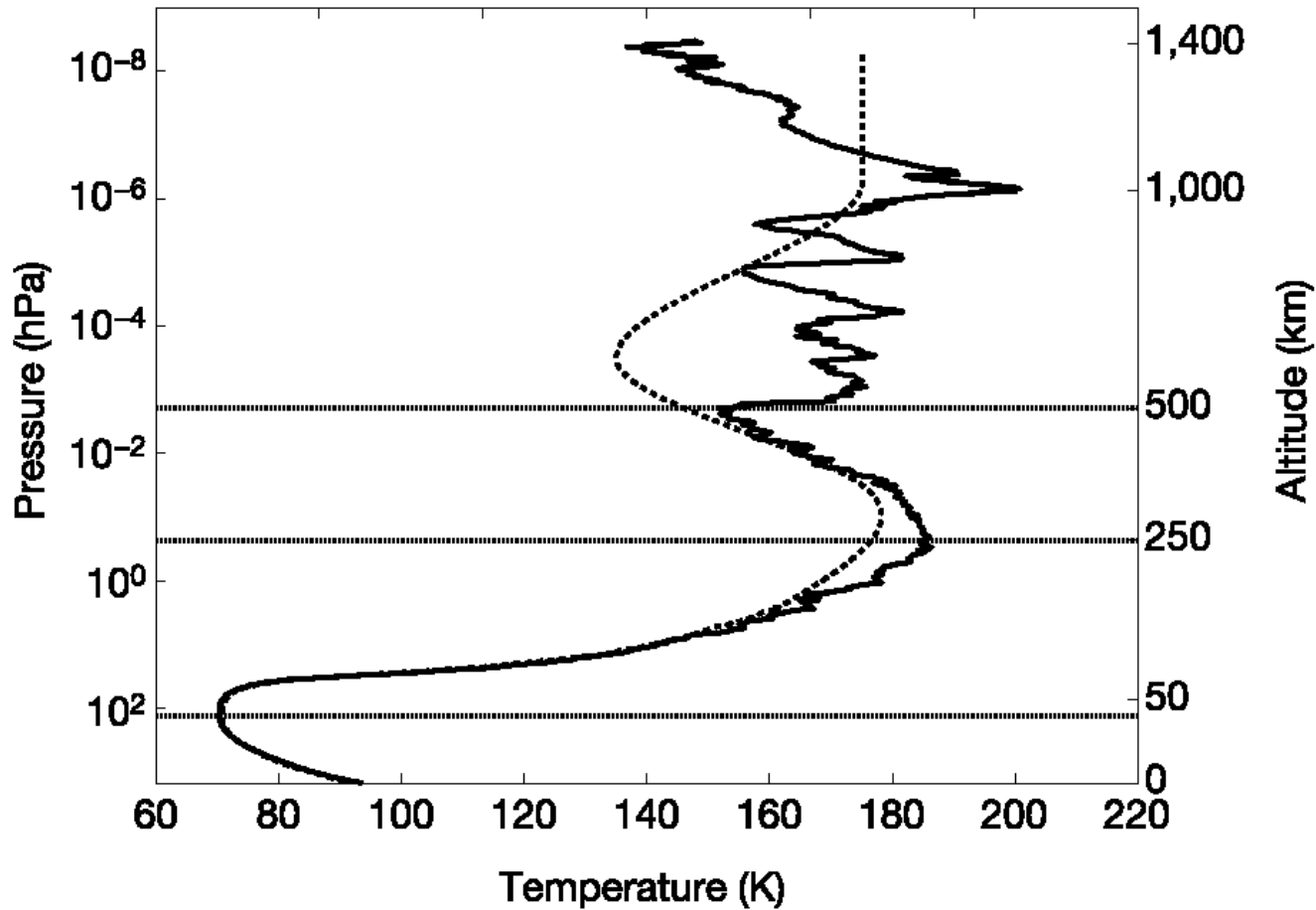

Huygens Atmospheric Structure Instrument

High-altitude temperature profile derived from aerodynamic deceleration (in fact, the accelerometer was the most sensitive used on a planetary mission - a few micro-g, picked up the atmosphere at 1500km!)

Mesosphere (minimum in dotted line) was basically absent! Lots of small-scale structure due to gravity waves and possibly tides.

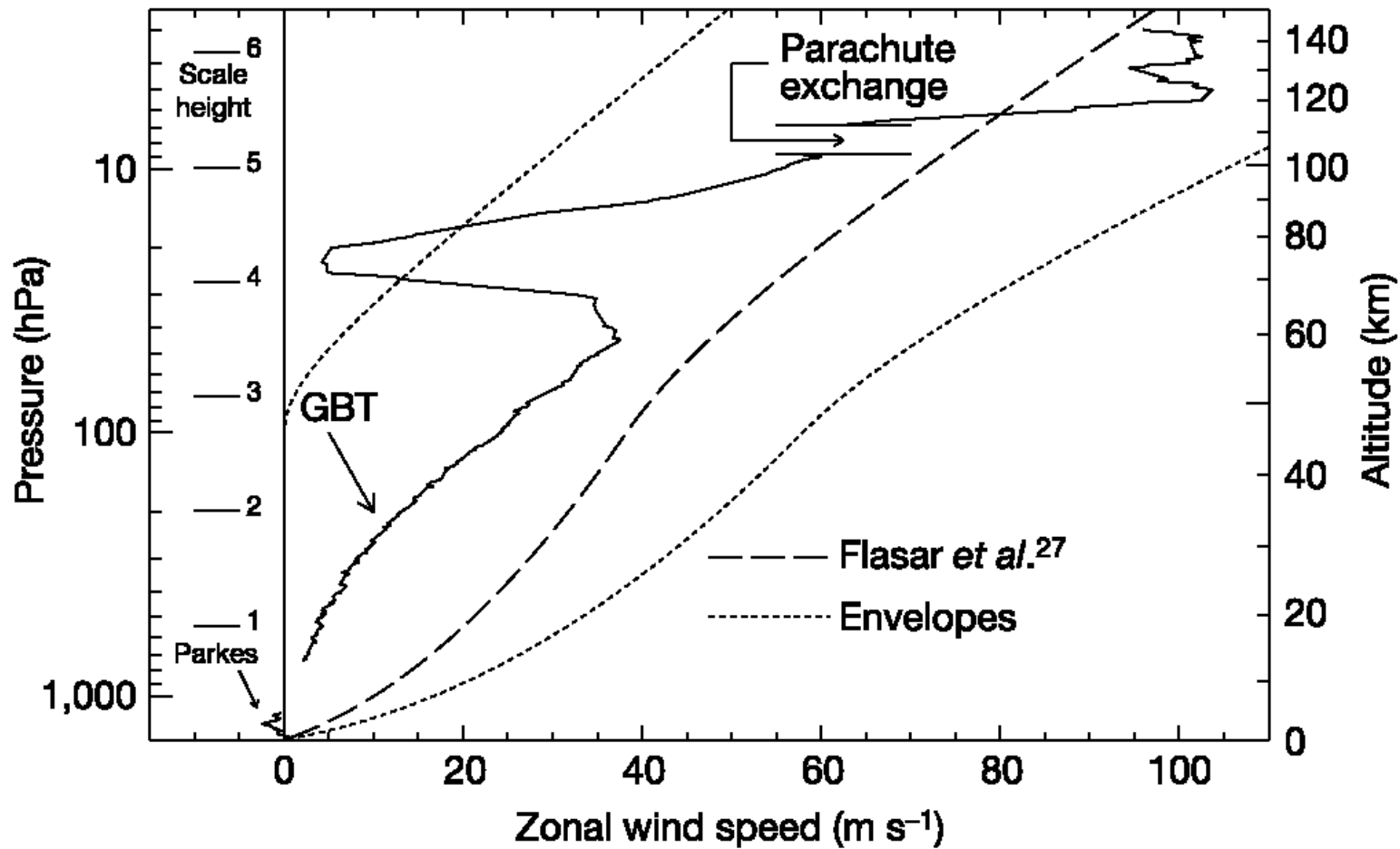

Doppler Wind Experiment (using groundbased rather than Cassini data !)

showed zonal winds to be somewhat weaker than expected (image overlap), with a slightly surprising reversal near the surface. Also somewhat unexpected was a layer of strong wind shear, with winds falling to near zero at about 80km altitude.

Cassini VIMS Titan Ta Base Map and Predicted Huygens DISR Image Coverage
(Combined HRI and MRI coverage for nominal wind model)

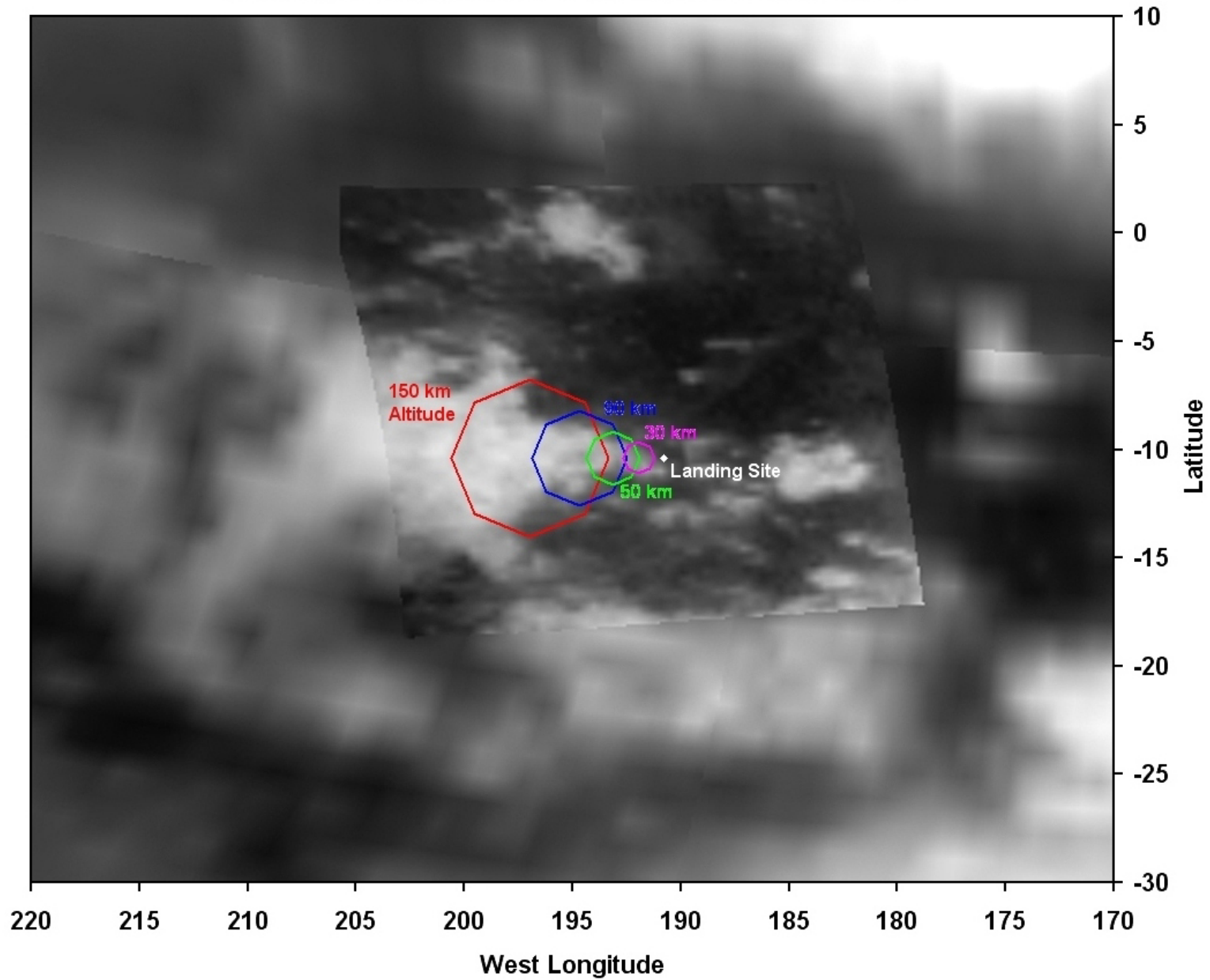

Cassini VIMS Basemap with Guesstimate of Location of DISR Mosaic of Huygens Landing Site (\sim error ± 1 deg)

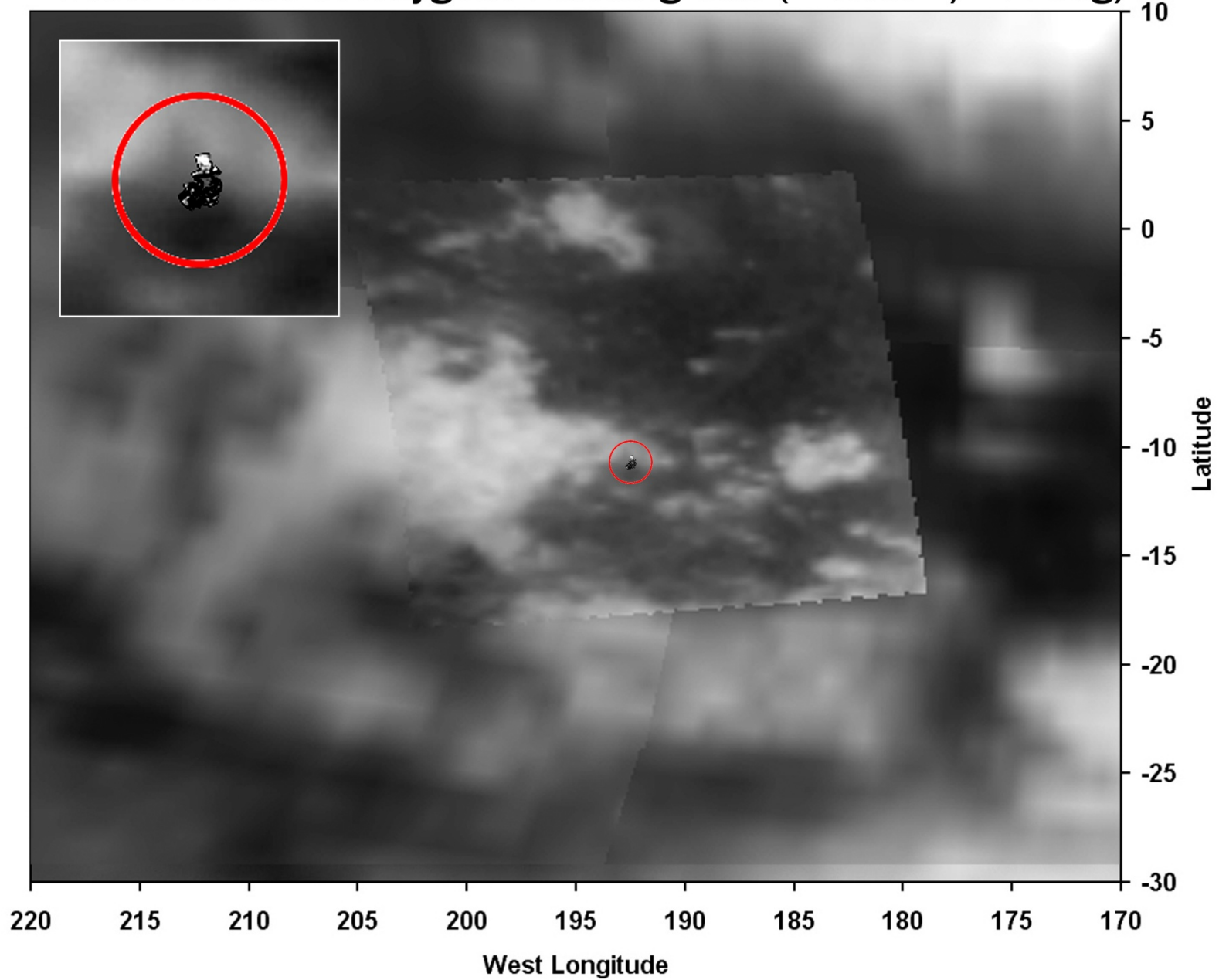

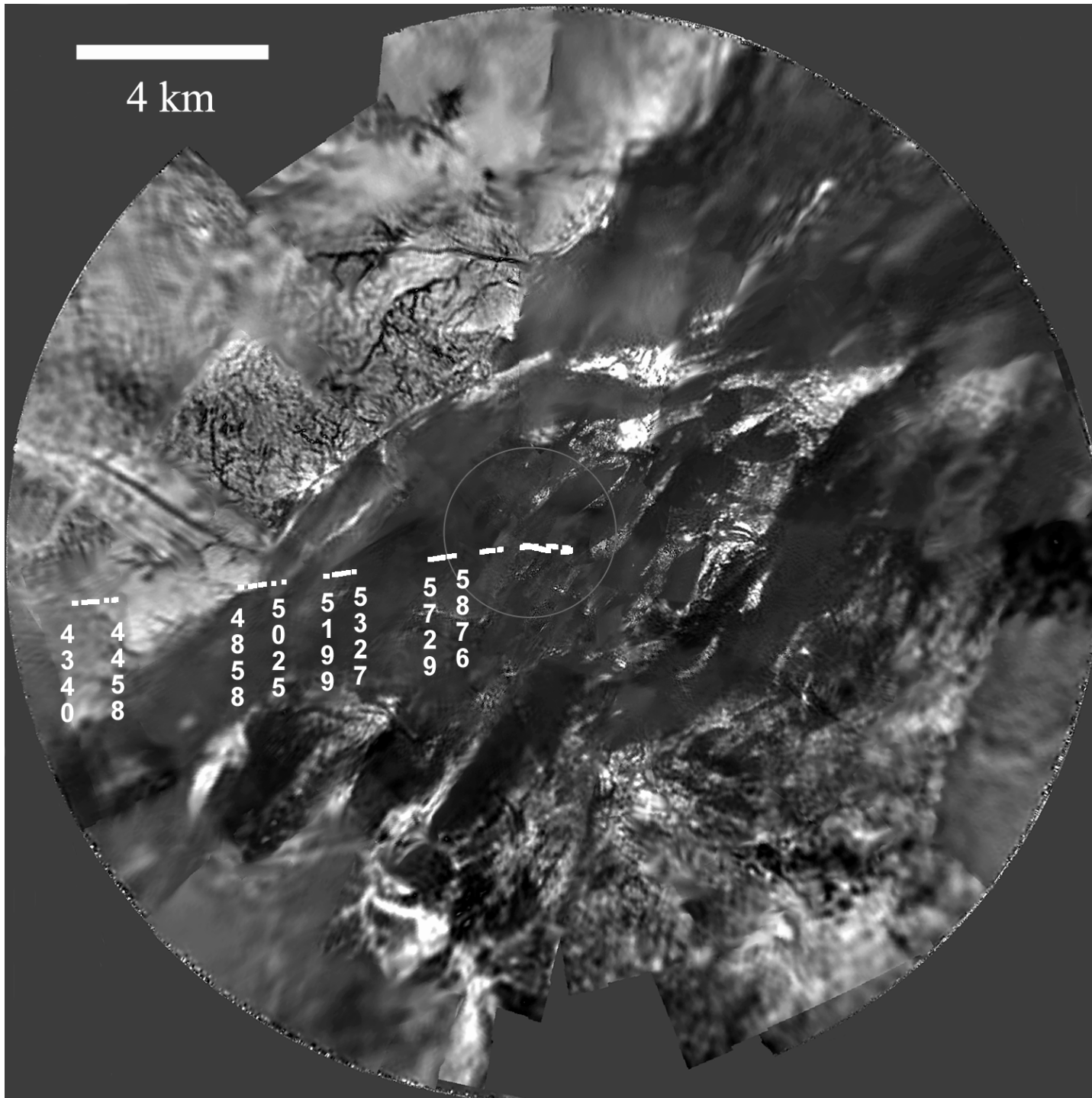

Descent groundtrack fortuitously crossed bright/dark boundary.

Brighter terrain elevated by ~100m ; pluvial and sapping networks.

Flatter, lower, but not smooth dark terrain.

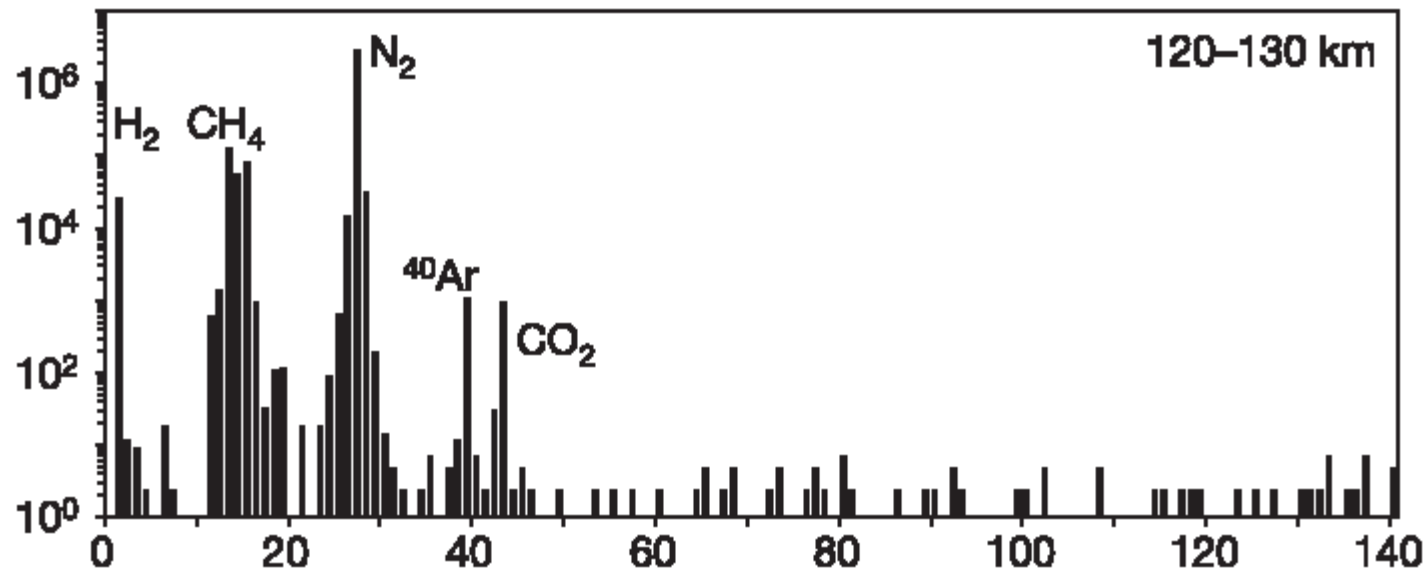

Gas Chromatograph/Mass Spectrometer

Atmospheric mass spectrum rather sparse

Radiogenic ^{40}Ar was detected at a mole fraction of 4.3×10^{-5} .

No other noble gases. Trace ($\sim 2.8 \times 10^{-7}$) of ^{36}Ar - suggests N_2 was brought to the system as a less volatile species, probably NH_3 .

Isotopic ratios $^{12}\text{C}/^{13}\text{C}$ is 82.3 ; $^{14}\text{N}/^{15}\text{N}$ is 183 ; D/H is 2.3×10^{-4}

Suggests Nitrogen is fractionated (although fractionation in N_2 is much less than in HCN measured from Earth), carbon is not (Early loss of N_2 during T-Tauri winds ; methane was still sequestered in interior ?)

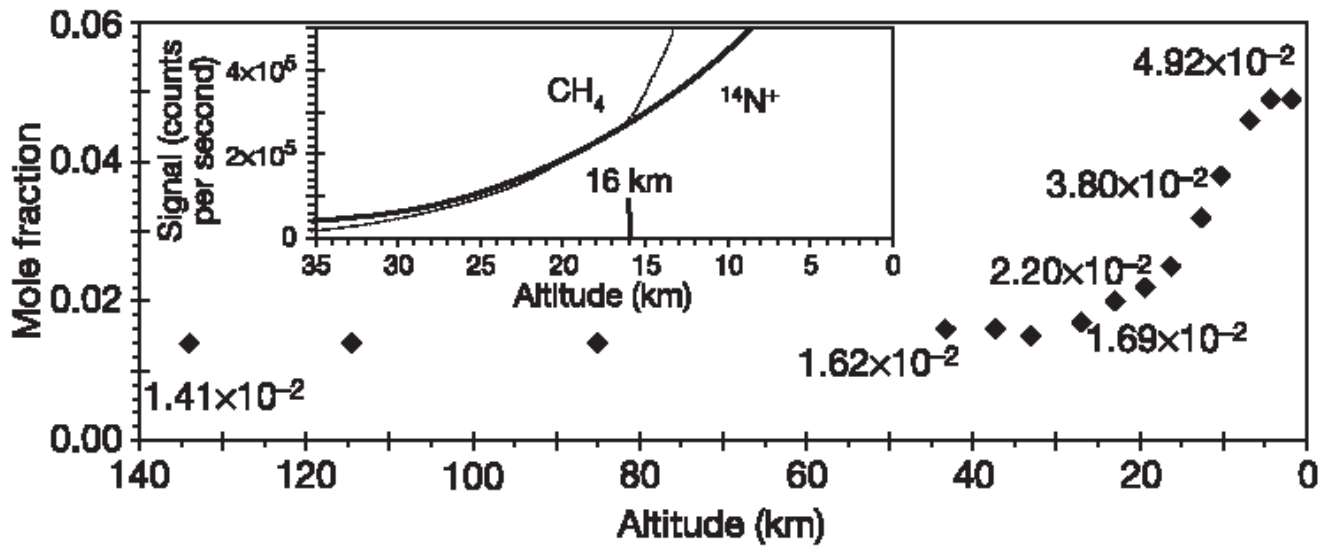

GCMS data show rise in CH₄ mole fraction (cf water on Earth) towards surface. Abundance ~1.4% at tropopause cold trap; ~5% (~50% relative humidity) at surface

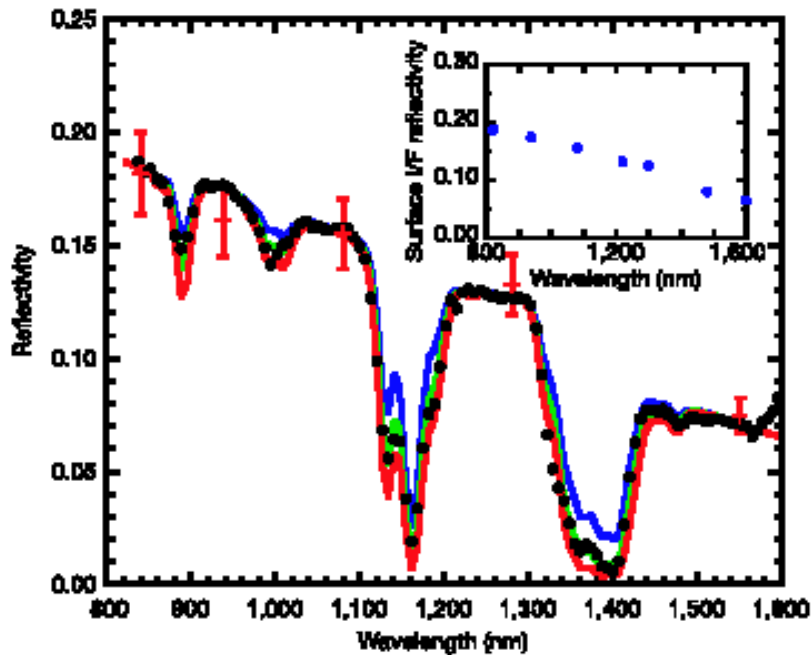

DISR derivation of methane mole fraction. Lamp-only downward looking spectrum from altitude of 21m (black data points). This spectrum is compared to three models: 3% (blue), 5% (green), and 7% (red) methane mole fractions. These models make use of surface reflectivity at seven wavelengths (blue dots in inset)

Useful to have independent means of measuring crucial parameters

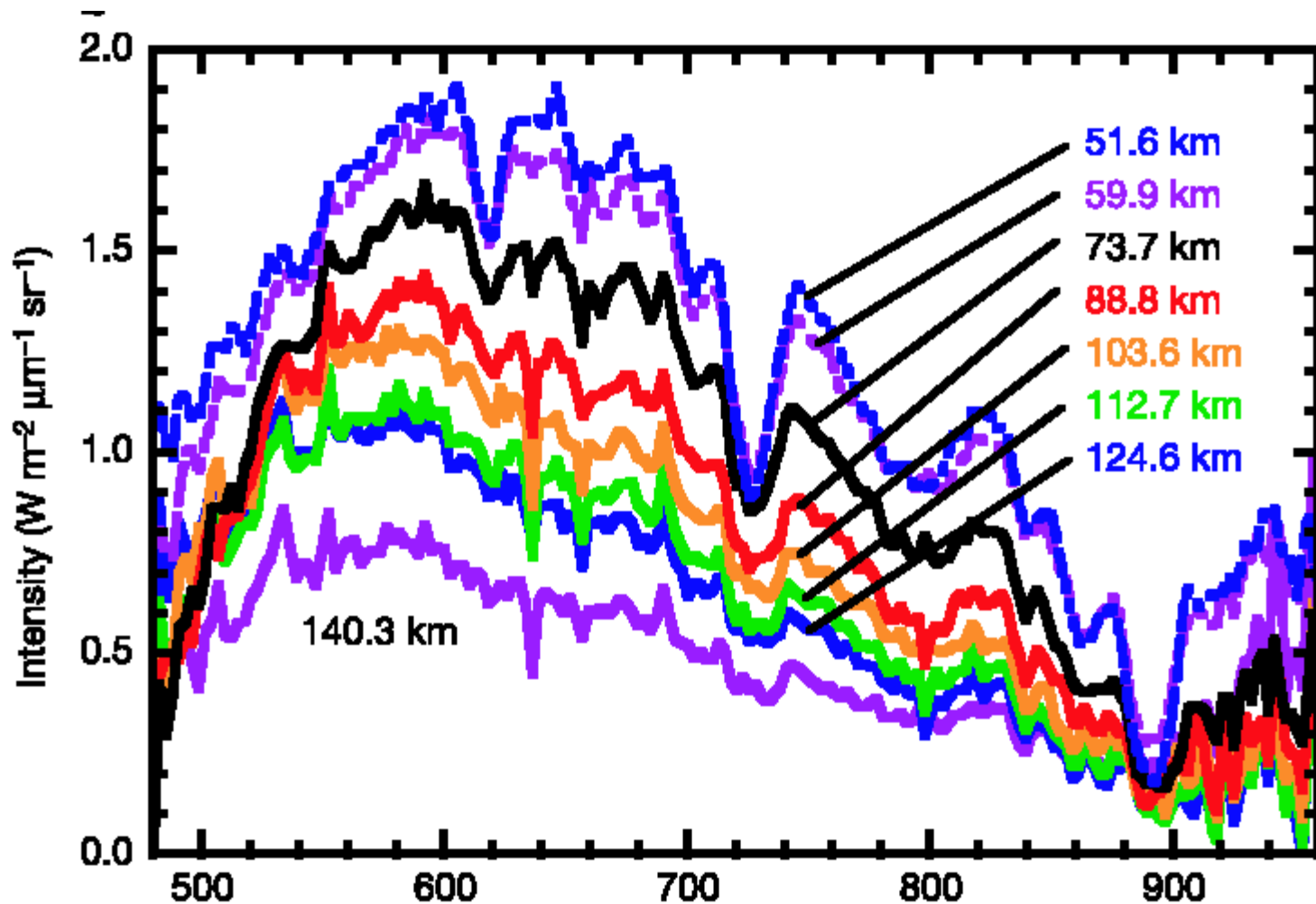

Descent Imager / Spectral Radiometer

example - upward looking spectrometer (looking away from sun) As probe descends, sky gets brighter, as on Earth, but methane bands get deeper. These data will allow recovery of haze abundance with altitude, haze particle size, etc. and greatly improve interpretation of Cassini orbiter spectra

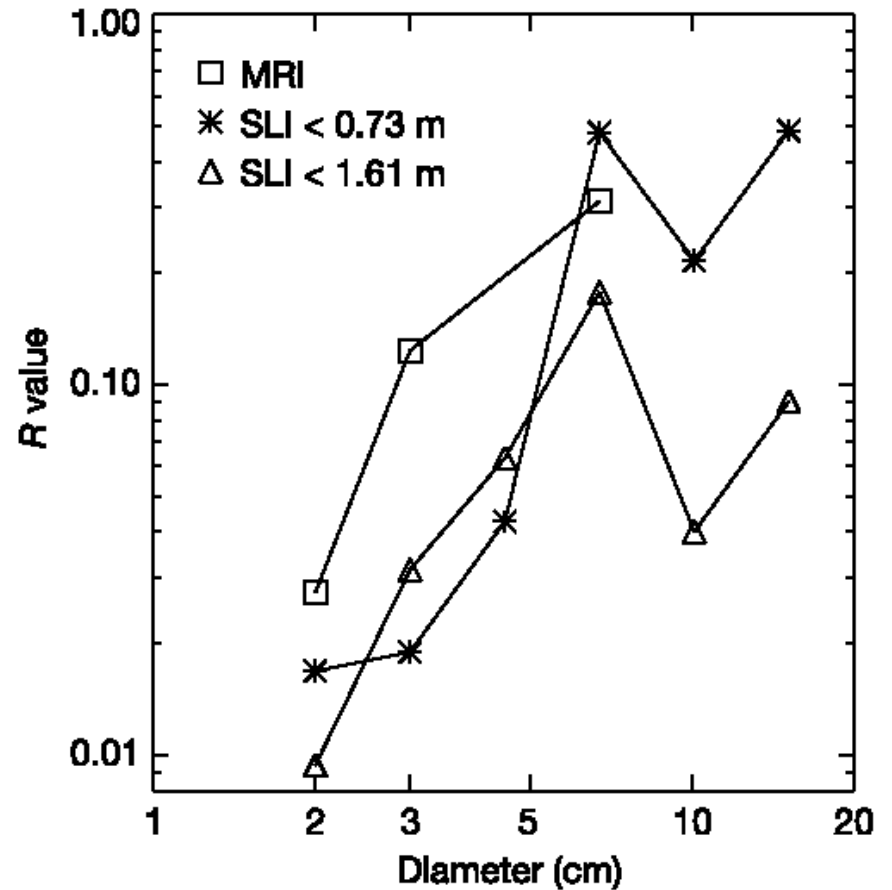
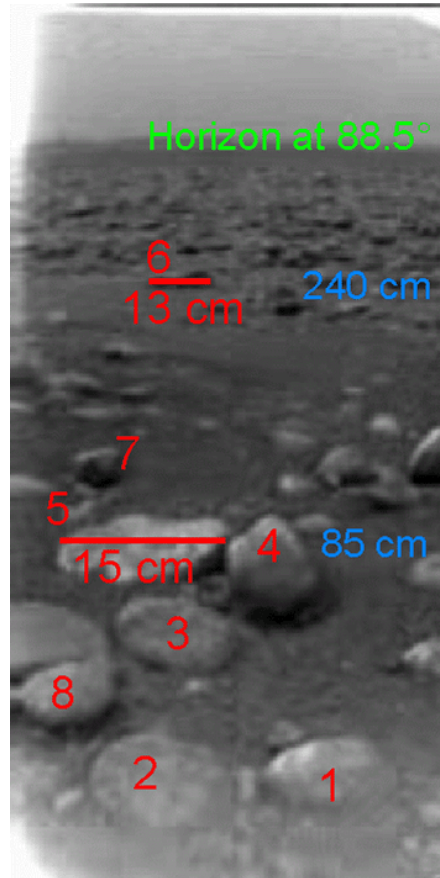

Surface Images

(Roughly pointed due south, judging from shadows and extrapolation of pre-impact spin rate)

Rounded cobbles. Small pebbles carried away - evidence of fluvial transport

Impact!

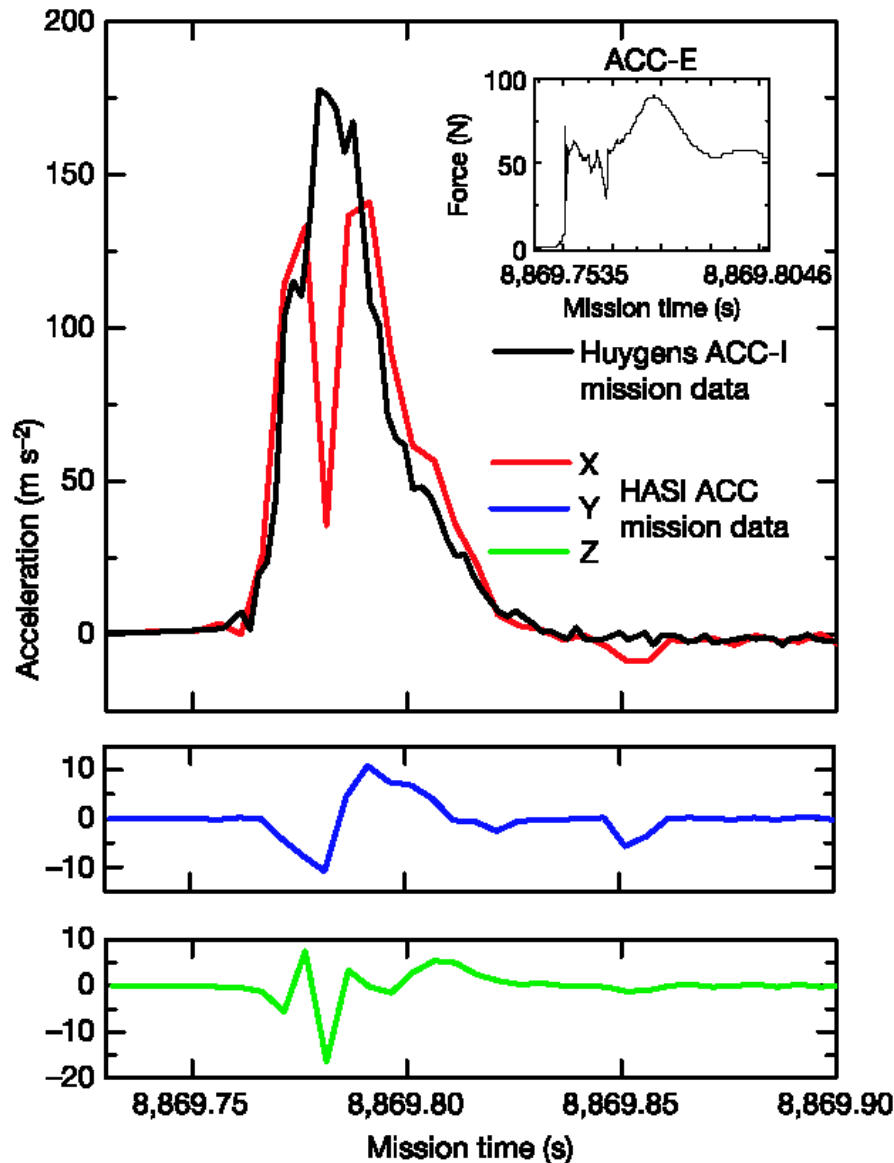

Hit Soft solid surface. (Like wet or dry sand; wet clay; packed snow)

Delta Vel = 4.63 m/s for ACC-I.

Delta Vel = 4.33 m/s for PZR-X.

Possible slight 'bounce' (few cm)

Peak deceleration ~15g, implies bearing strength of ~50 kPa. Rapid onset suggests material did not need to be compacted before resisting - i.e. not fluffy. Analogs - damp sand, clay, packed snow

The Penetrometer on the Huygens Probe

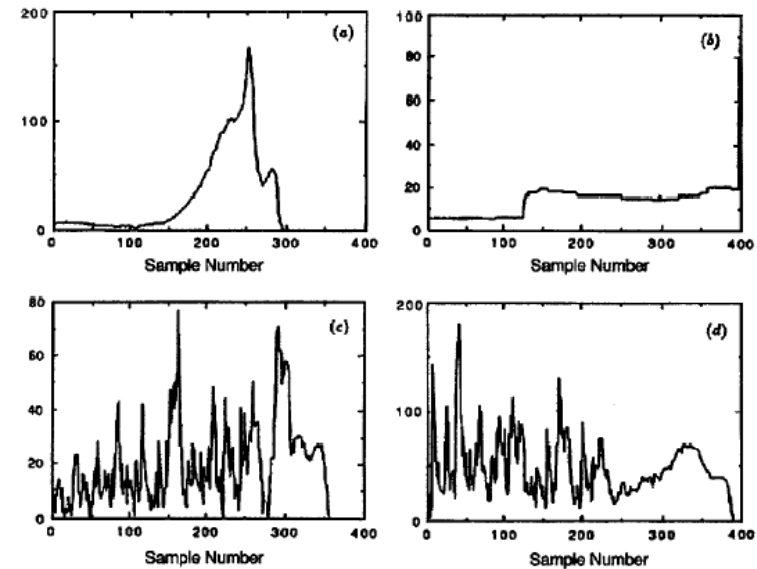
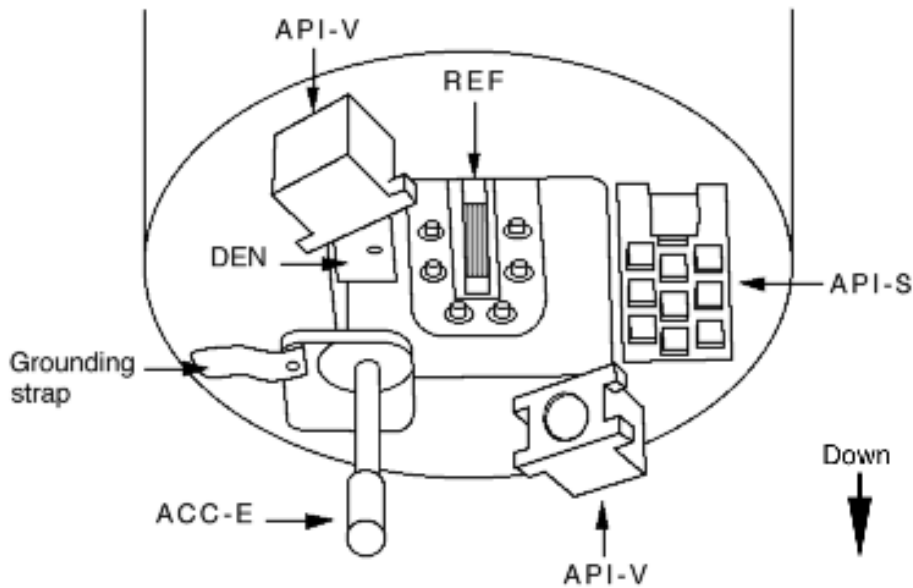
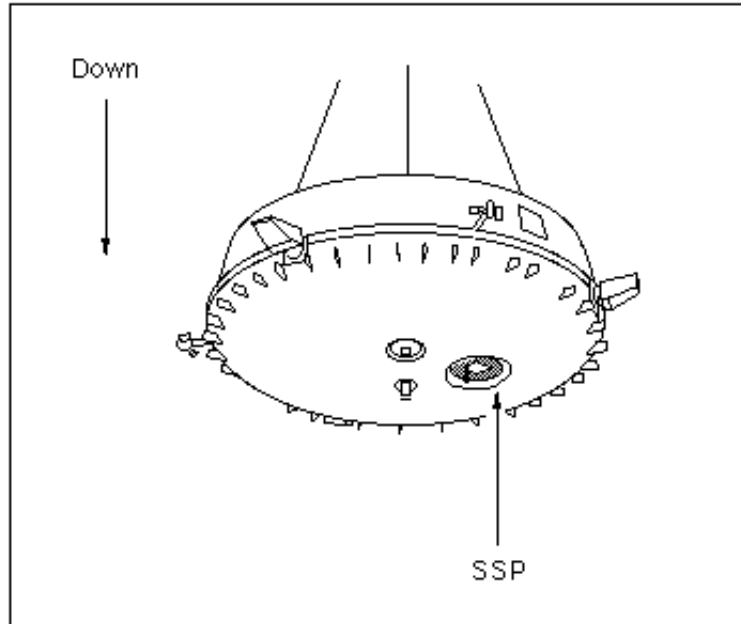

Data taken in the lab in 1994 – (a) dry sand (b) wet clay (c) fine gravel (d) coarse gravel (from R. D. Lorenz, et al 'An Impact Penetrometer for a Landing Spacecraft', *Measurement Science and Technology*, vol.5 pp.1033-1041, 1994 also at <http://www.lpl.arizona.edu/~rlorenz>)

The Penetrometer on the Huygens Probe

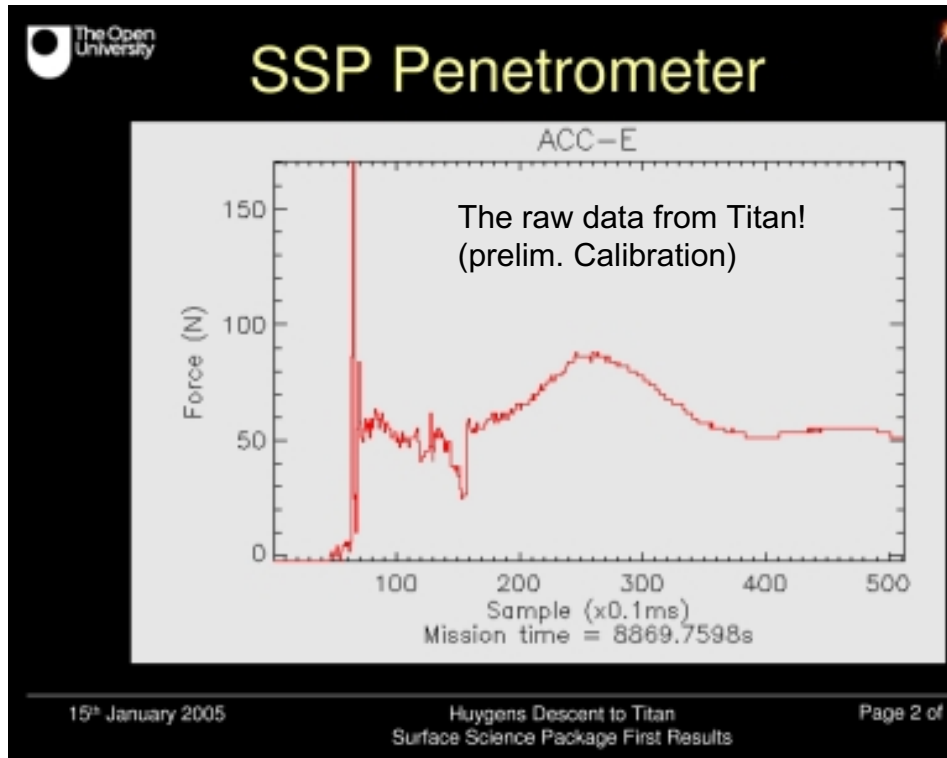

near-constant force, plus spike at onset ('creme brulee') $50\text{N}/2\text{cm}^2 \sim 250\text{kPa}$. Not consistent with dry sand.

Penetrometer struck a pebble ?

Note shallow onset – few mm of soft material on pebble ? (See Atkinson et al., submitted)

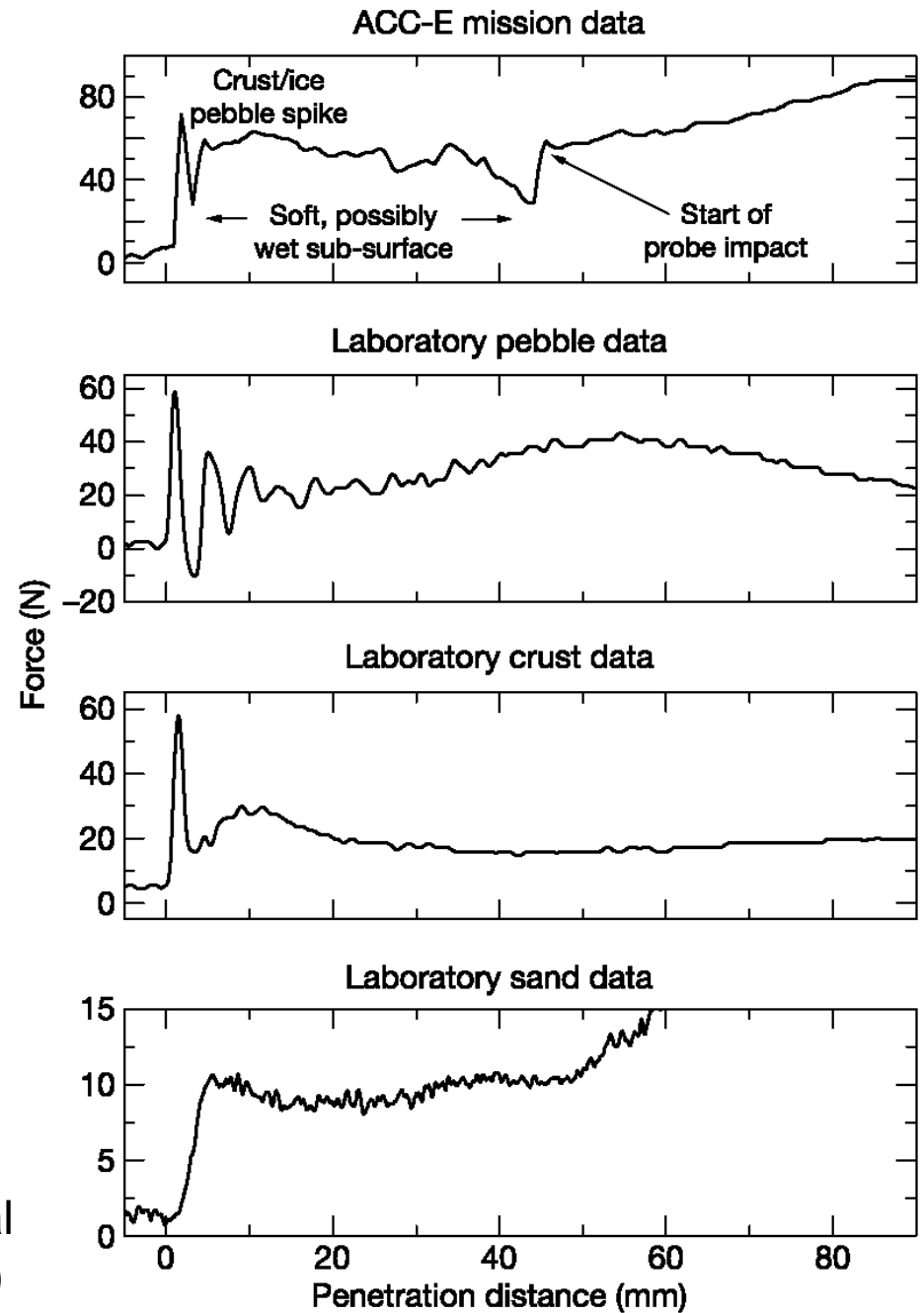

Two Similar Datasets ?

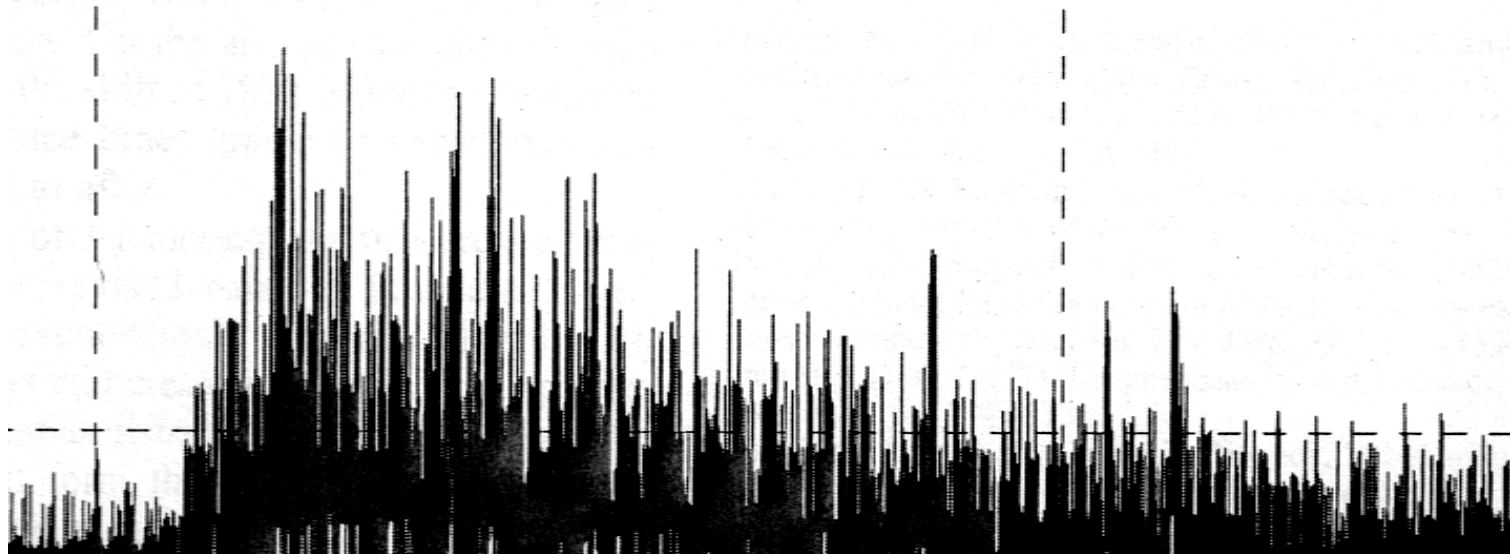
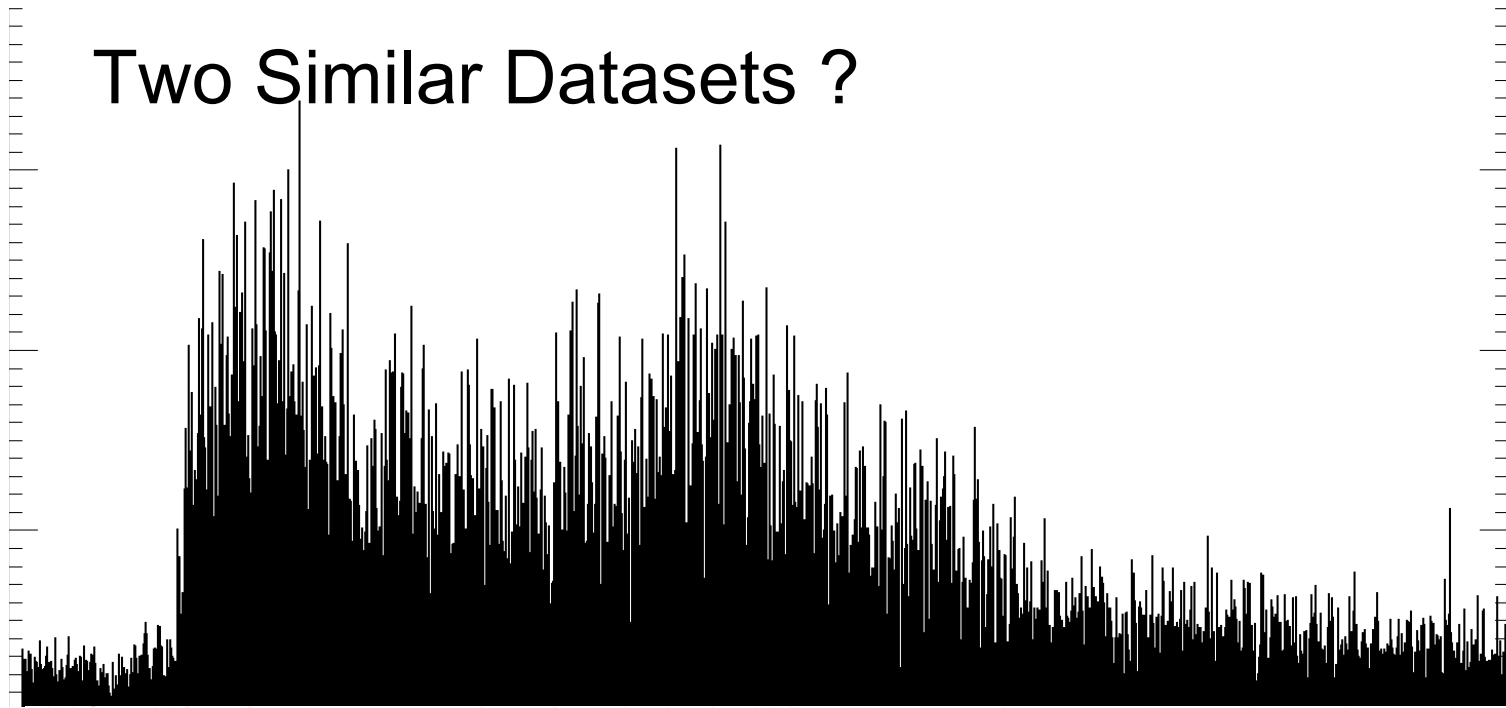

Huygens Probe Titan Descent
Radial Accelerometer B

0.04g

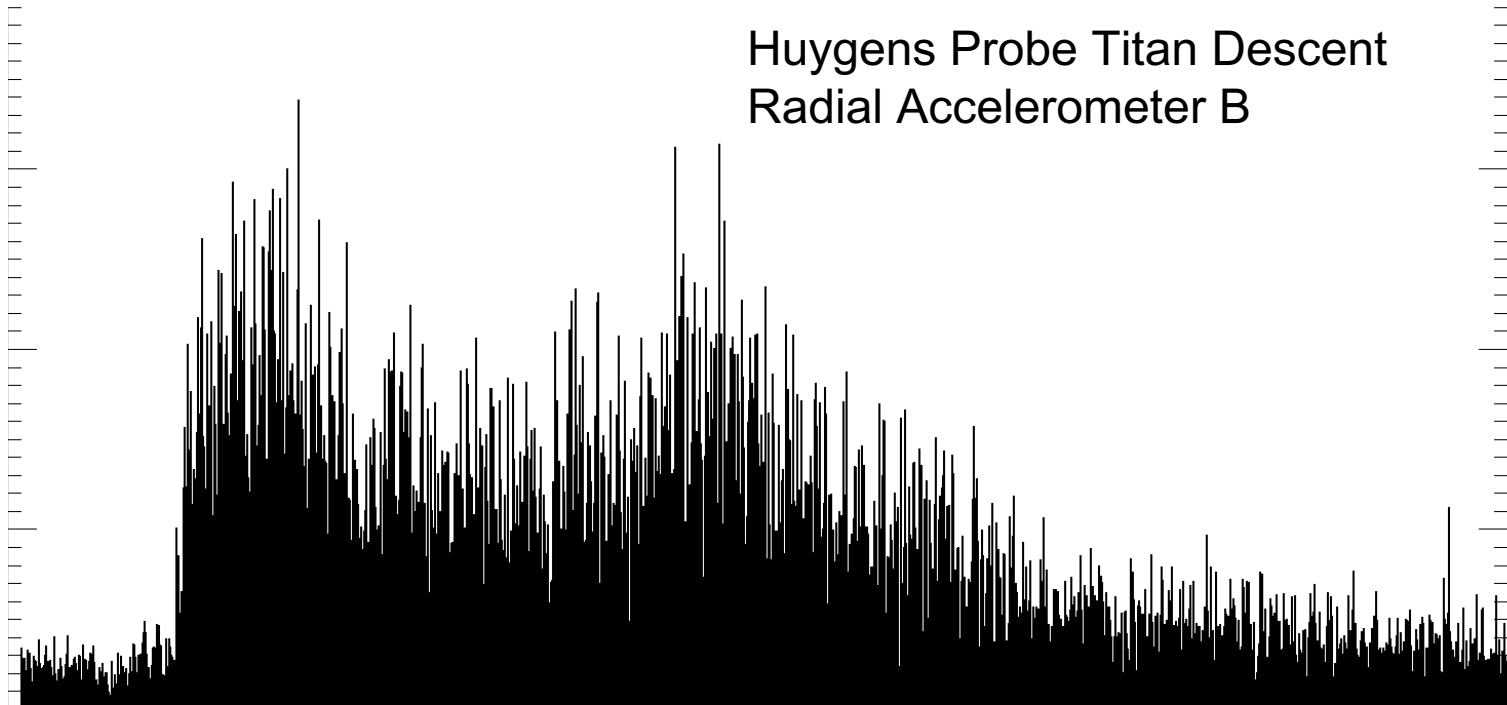

150 mins

Both datasets rendered useful by subtraction of running mean (cf 'unsharp mask')

Moonquake 1971 / 187
Apollo 14 Seismometer
Bulow et al, JGR, (2005)

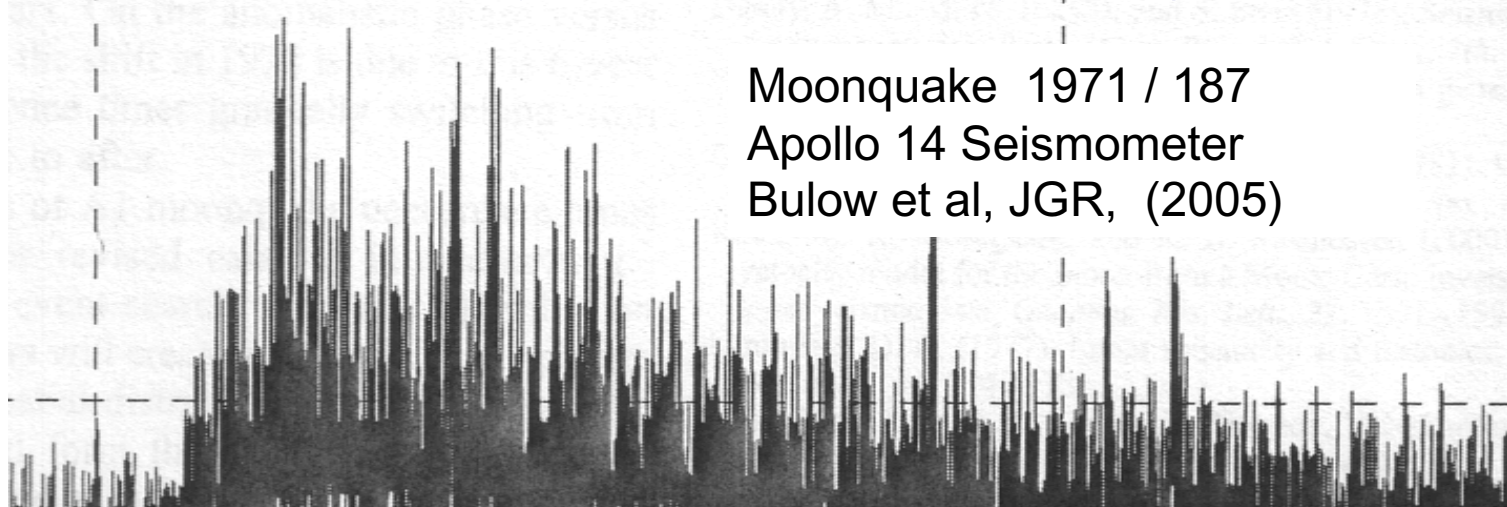

32 mins

TILT SENSOR DATA FROM SSP EXPERIMENT

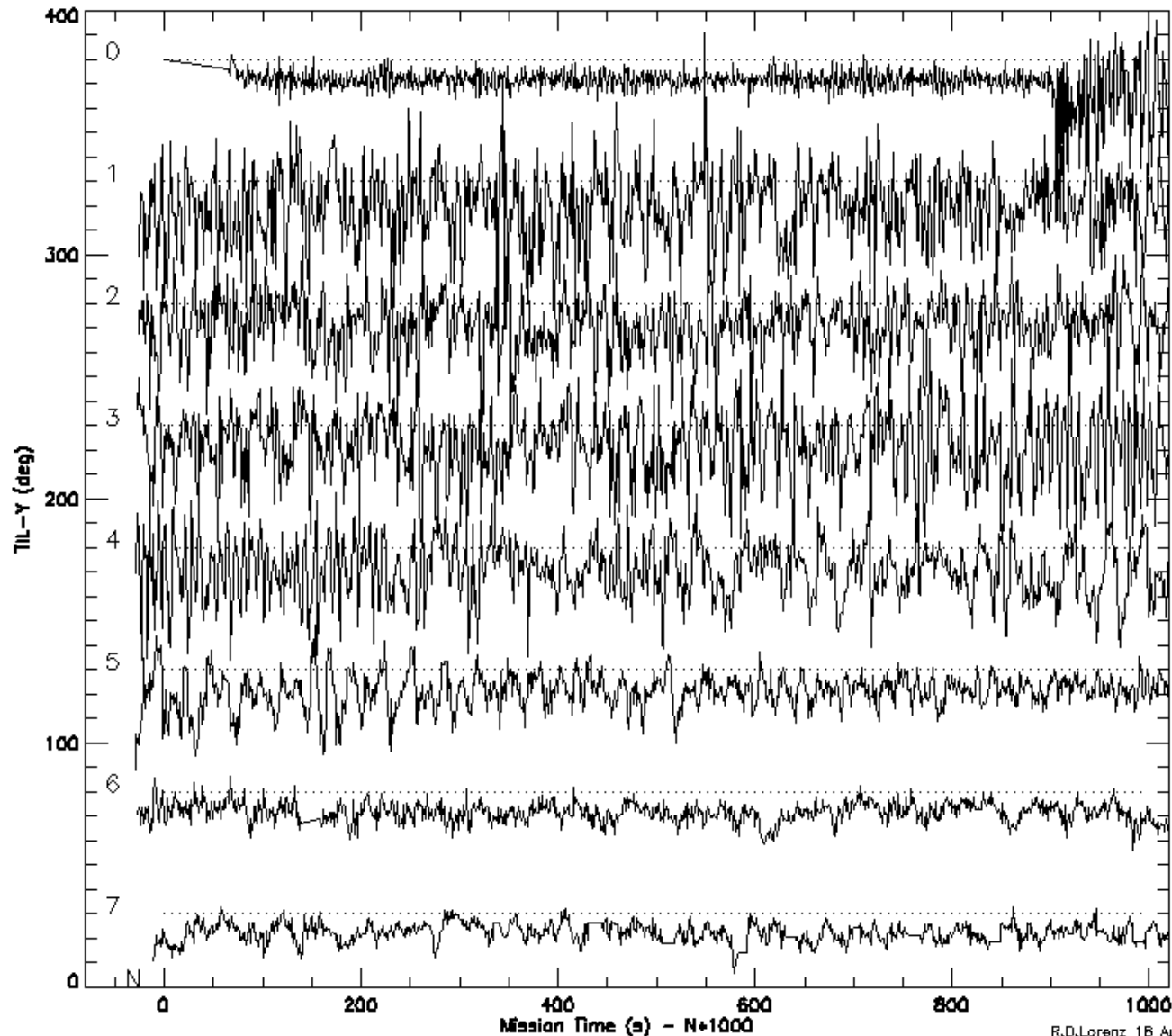

R.D.Lorenz 16 Aug 20

Y-TIL data is obviously rich in content. But how to extract/interpret ?

Evident changes in character at 900s and after ~5200s.

Maybe also a change around 4500s ?

Actual tilts of probe to Titan reference frame are much smaller than this indicated tilt, which includes a dynamic component

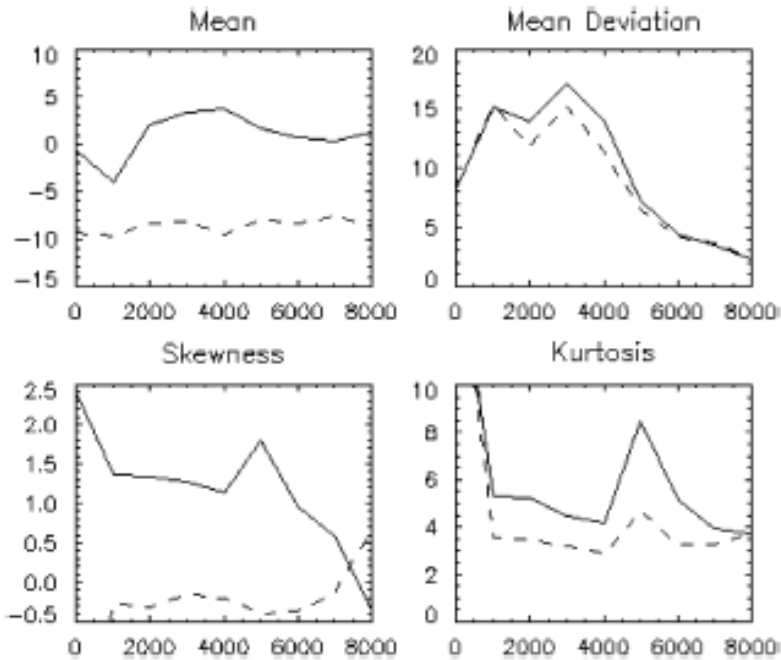

Statistical moments of probe motion from tilt sensor show pronounced excursion around 5000s

Motions substantially self-excited during descent (not very turbulent – 0.15 m/s)

See Planet. Space. Sci., 55, 1936

Frequency spectrum shows distinctive peak close to pendulum period during this interval.

Similar spectrum seen in instrumented balloon data on Earth - peaked spectrum seen in freezing/precipitating cloud layer

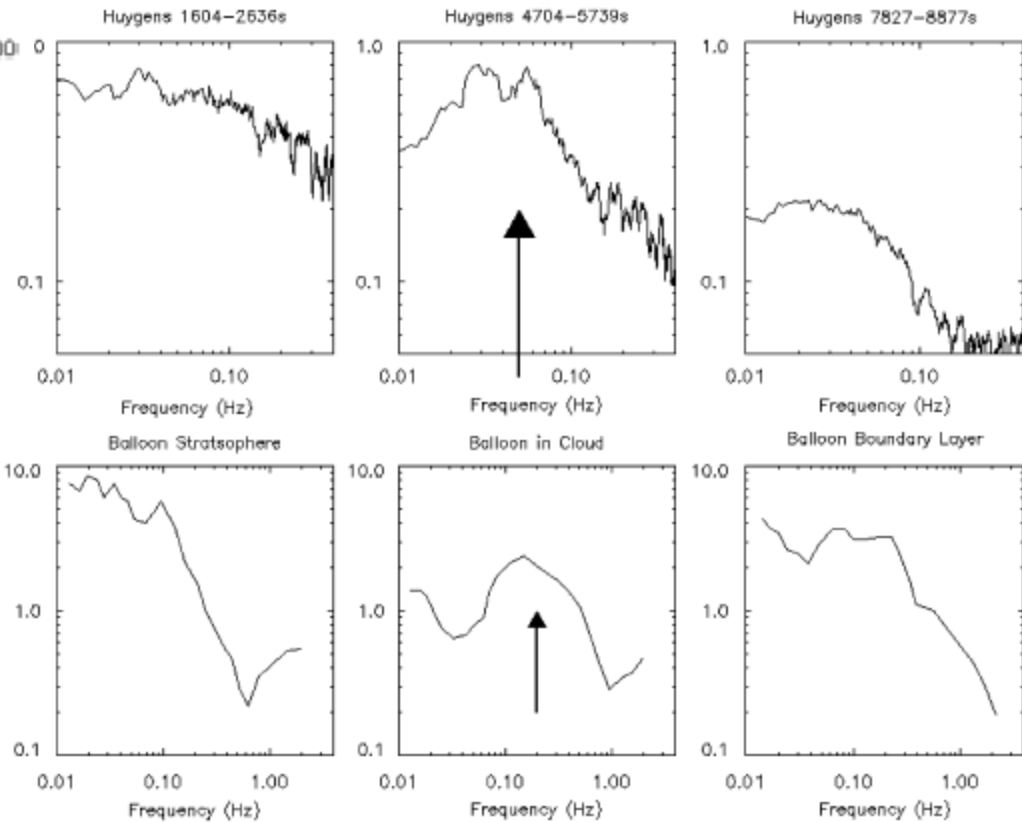

Probe Transmitter signal strength varies slightly with azimuth as well as elevation : some fluctuations expected due to probe spin

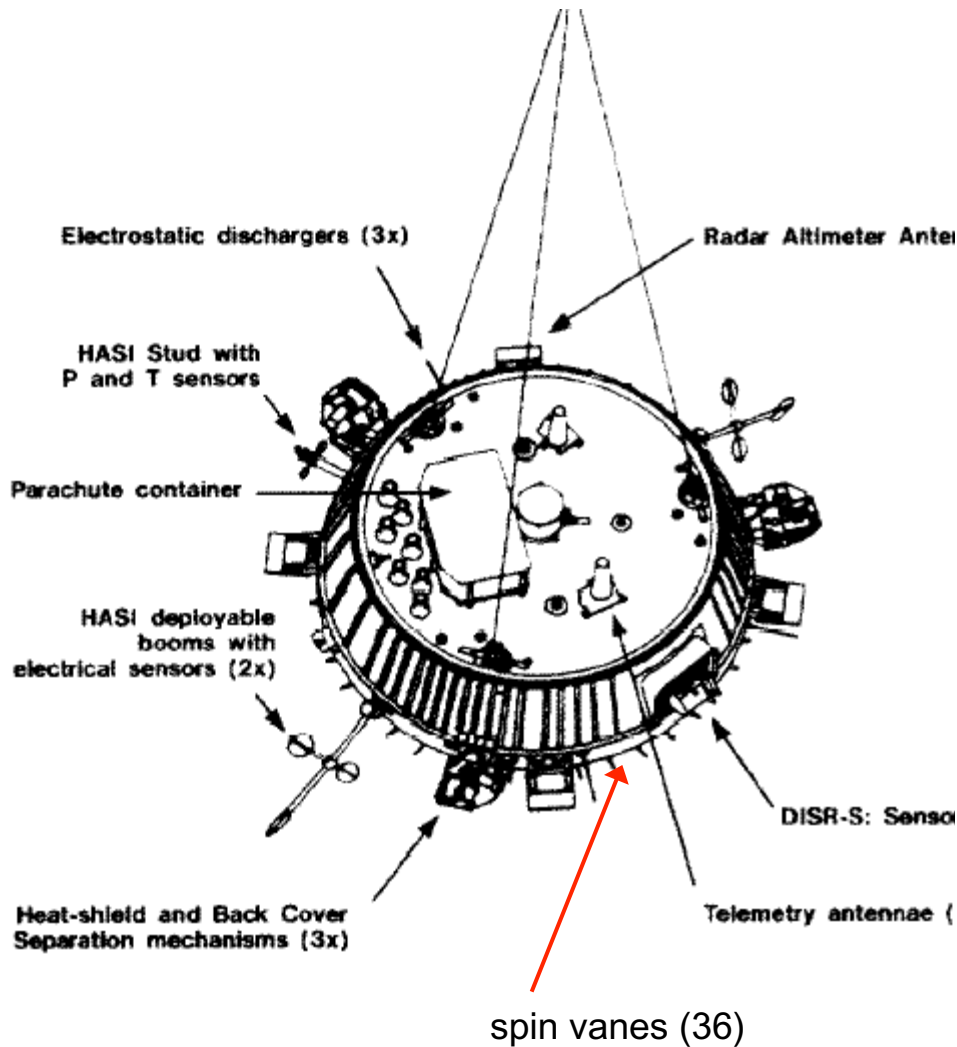

Probe Transmitter Antenna FM RCP 2098 MHz

Antenna Pattern [dB]

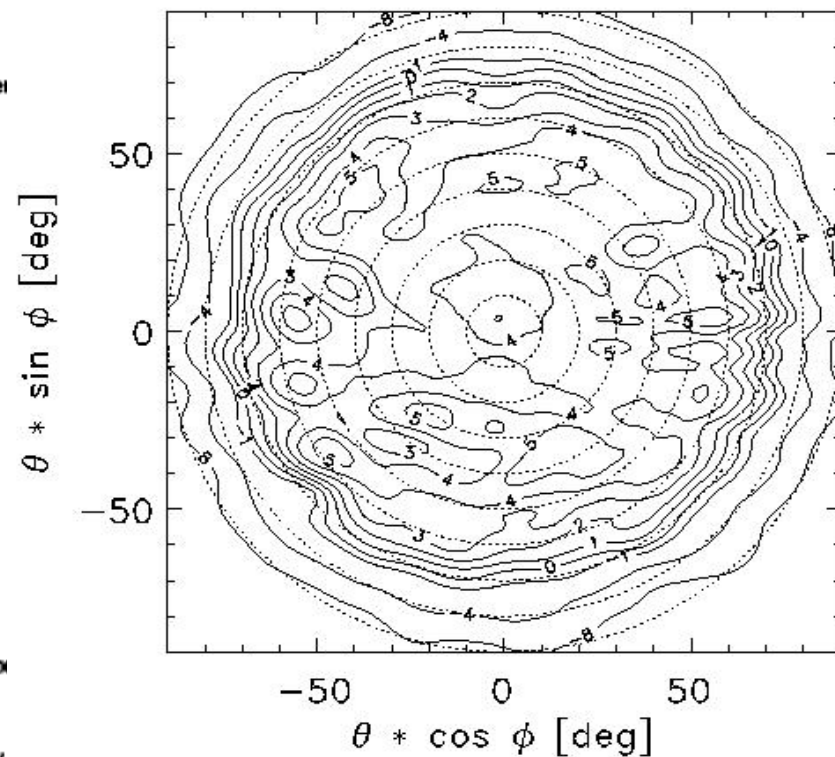

θ = Elevation Angle [0°, 90°]
 ϕ = Azimuth Angle [0°, 360°]

Periodic Spin modulation of AGC allows diagnosis of spin rate and direction

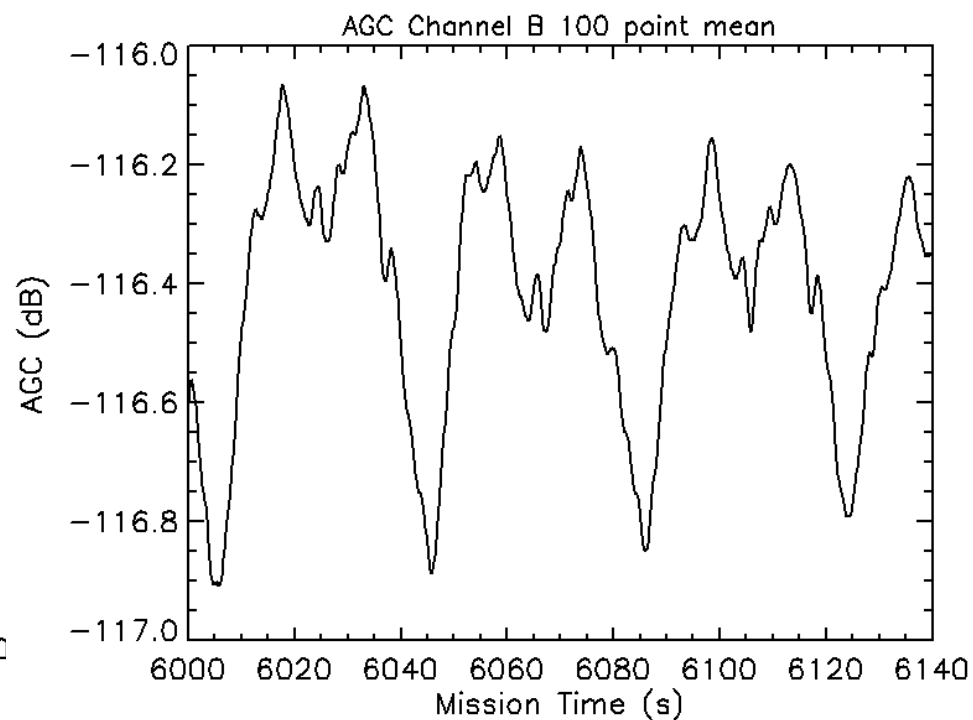
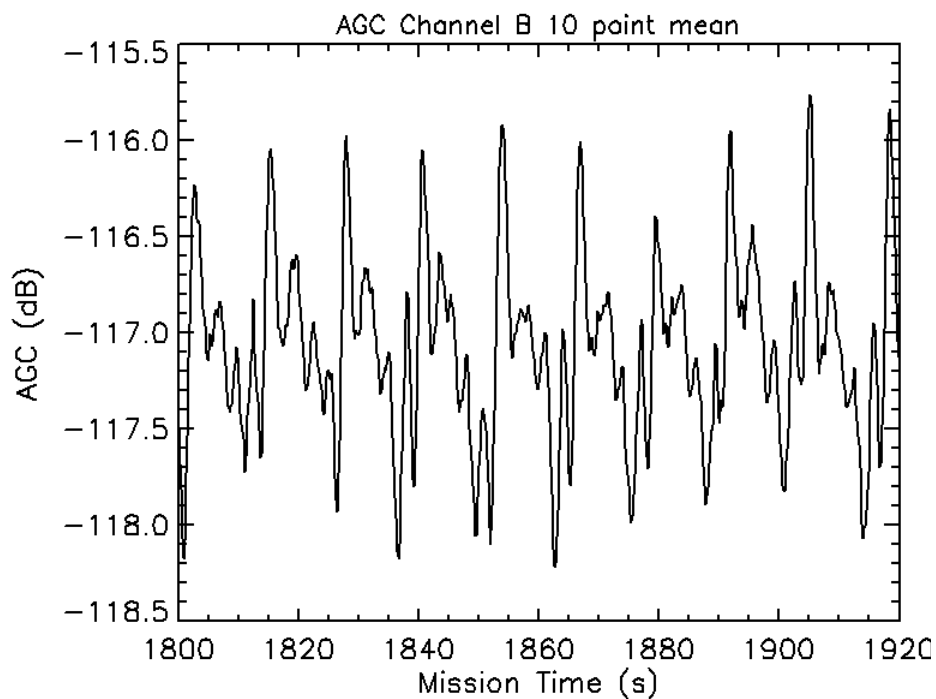

Signal strength history recorded on Cassini proved to be very rich and useful diagnostic of probe motion

Mission did not follow expected profile

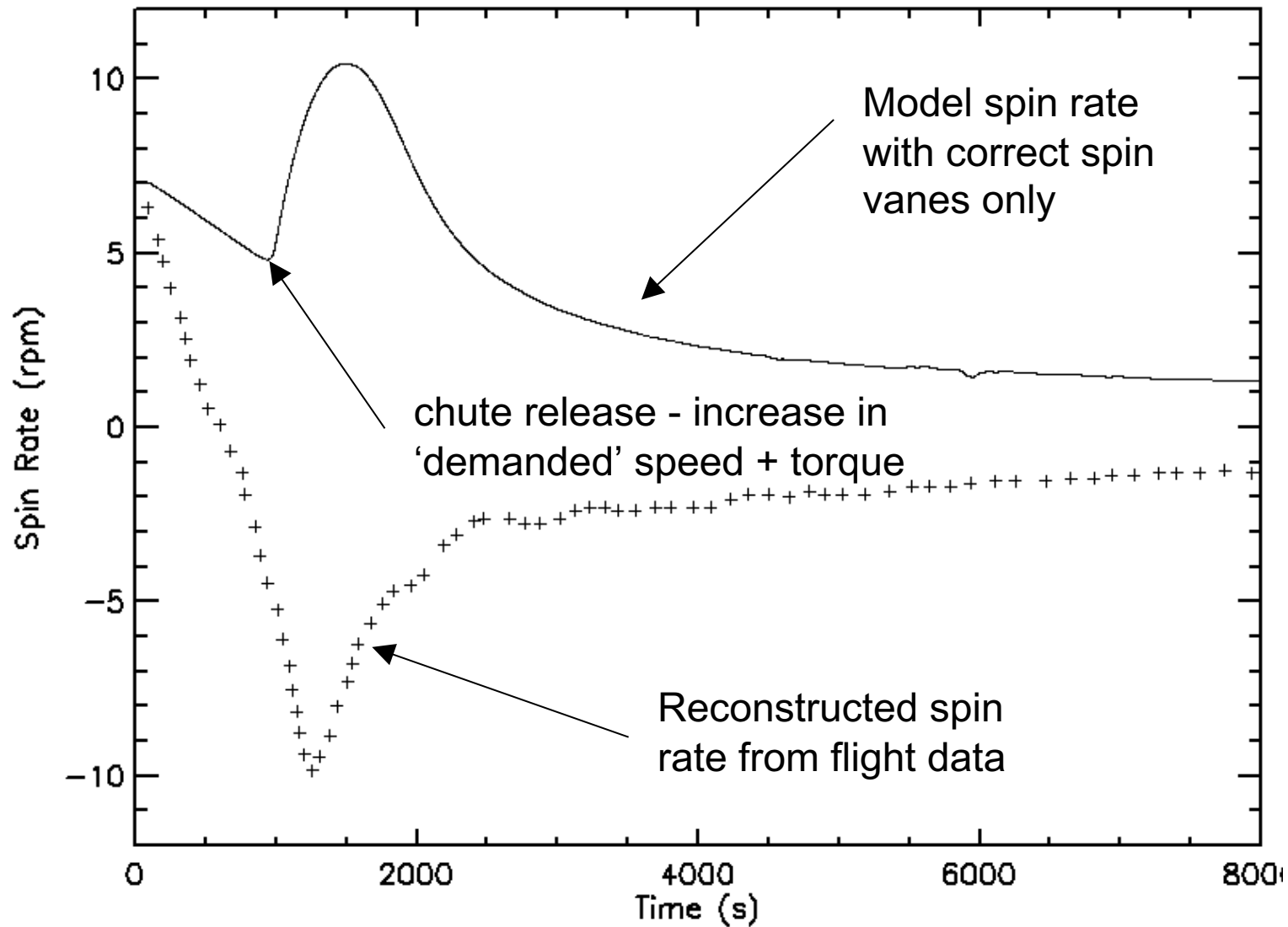

Reason for spin reversal still not fully understood, but suspected to be due to torque from attach fittings . See also J. Brit. Interplan. Soc., 59, 273, 2006

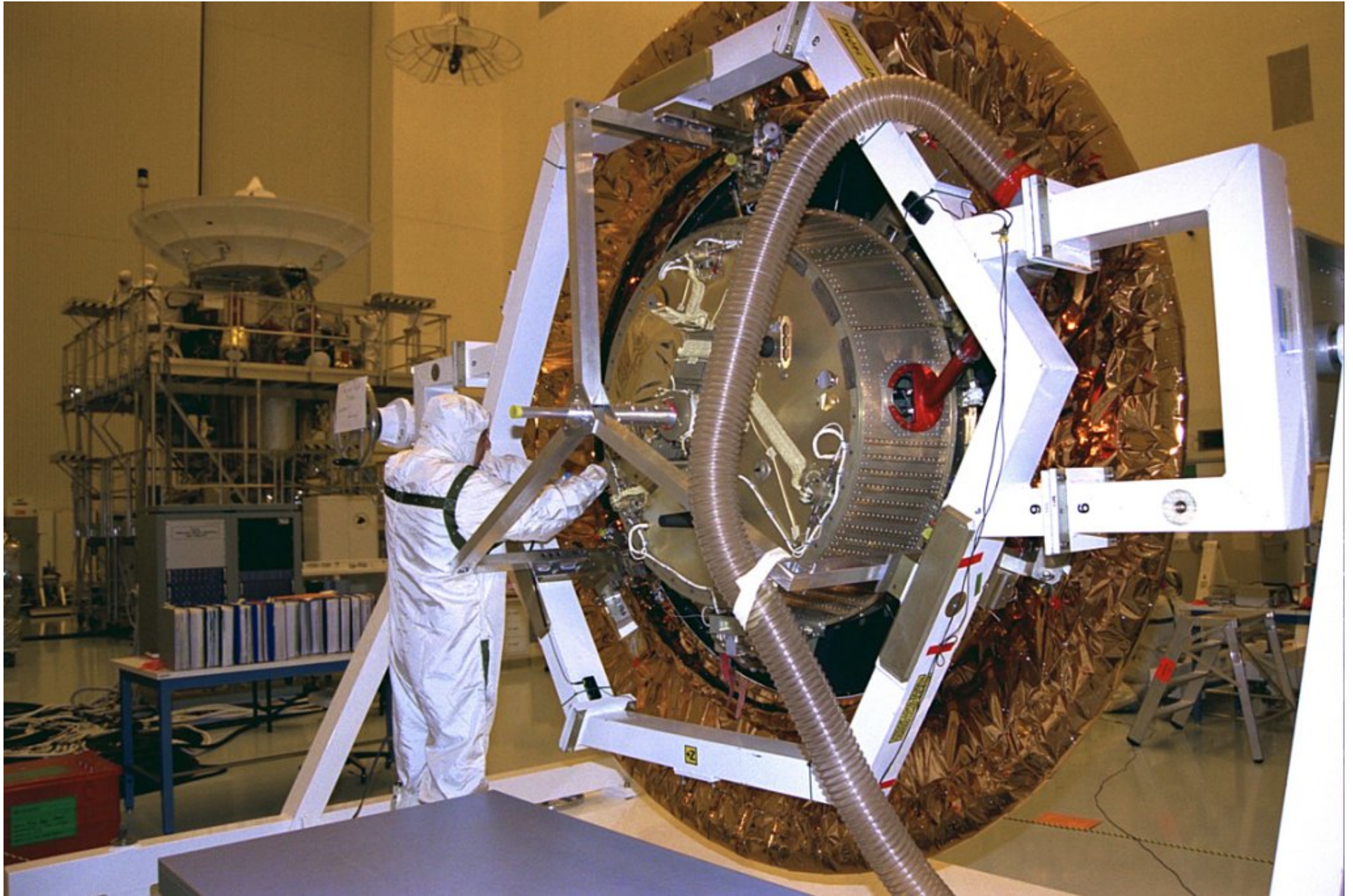

Huygens probe at KSC (Cassini in background). Note cold-air hose to remove heat from probe inside. KSC photo

Batt4b_D5017

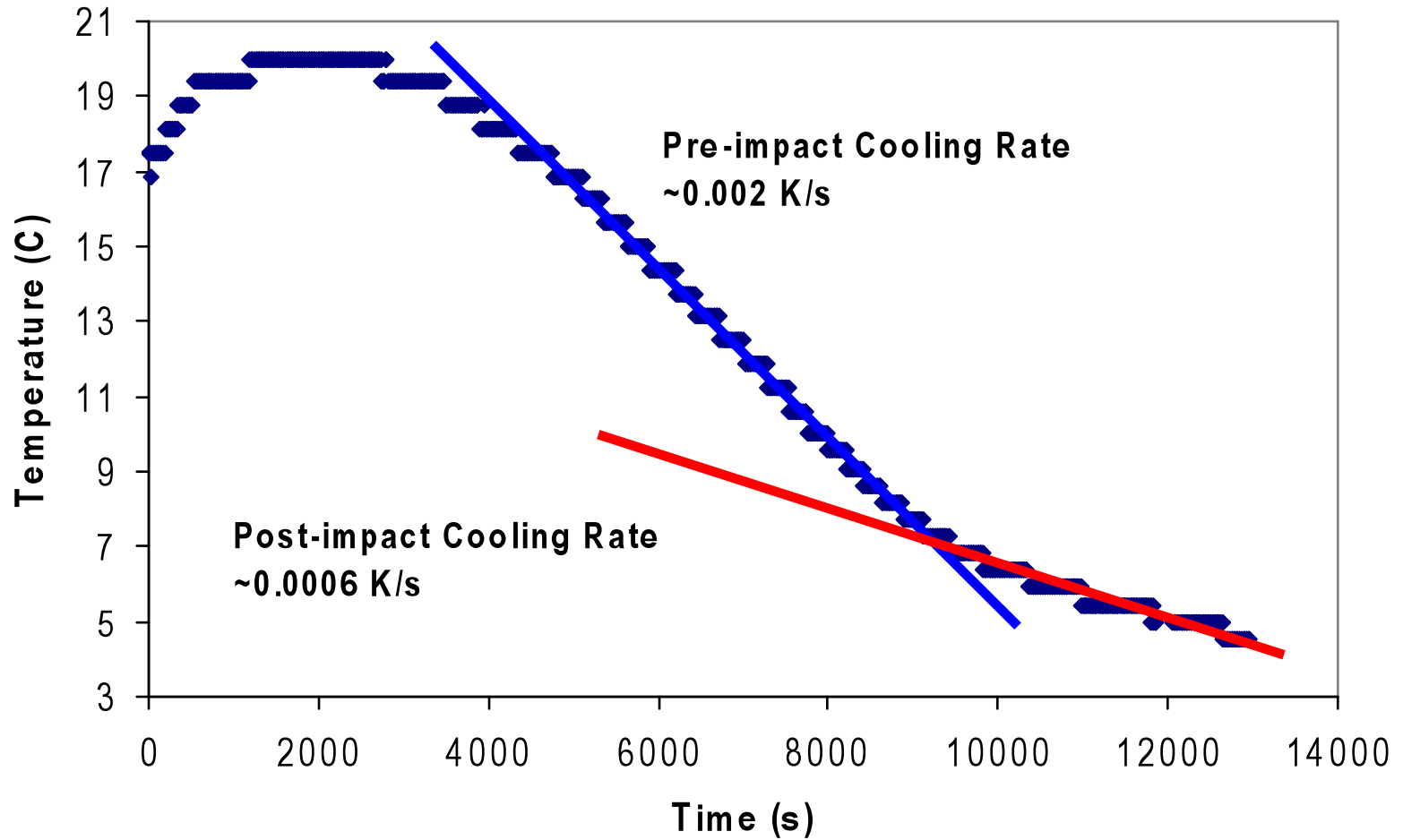

Huygens Thermal Budget

DESCENT

See Icarus, 182, 559-566, 2006

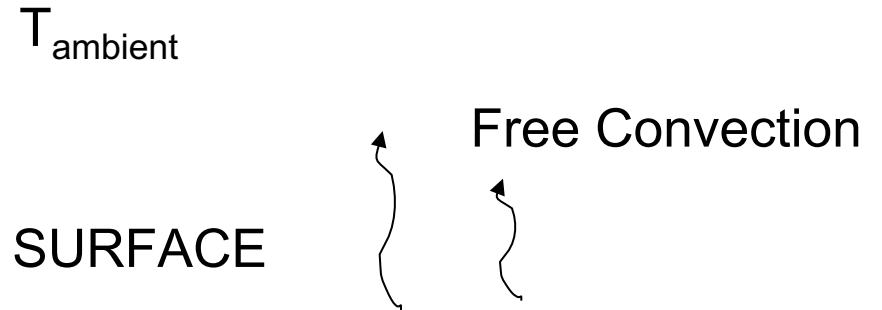
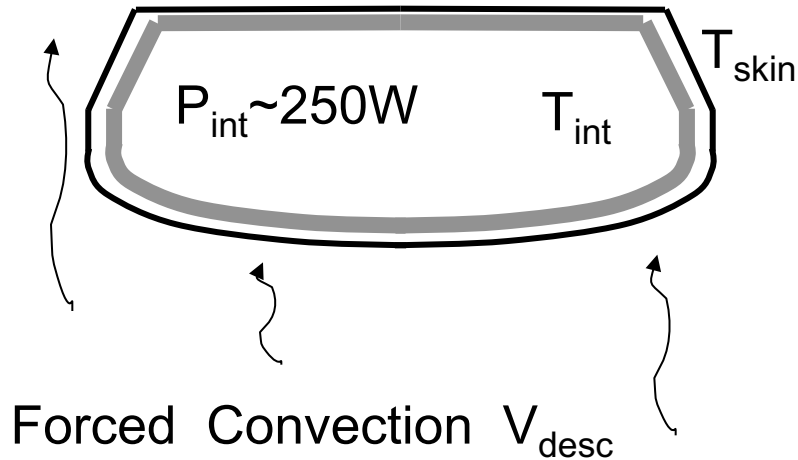

Forced
Convection
 V_{wind}

Conduction into surface
(plus evaporation?)

Radiative transfer $\sim 10 W$
not considered

Wind-Chill during and after Descent

- Interpretation needs foam insulation and internal heat generation to be taken into account.
- Total area $\sim 4\text{m}^2$. Heat transfer coefficient given by $h \sim 0.37(k/D) \text{Re}^{0.6}$ where Re is Reynolds #, increasing throughout descent. Reaches $\sim 30 \text{Wm}^{-2}\text{K}^{-1}$ prior to impact.
- Cooling of 0.002K/s means a net loss of 600W or 150Wm^{-2} , thus air:skin $\Delta T \sim 5 \text{K}$; $T_{\text{skin}} \sim 100 \text{K}$
- On ground 350W or $\sim 90 \text{Wm}^{-2}$. Taking change in internal heat transfer into account requires $h < 4 \text{Wm}^{-2}\text{K}^{-1}$ so to get coefficient h 8x lower than during descent at 5m/s requires surface winds $< \sim 0.2 \text{m/s}$

GCMS Heated inlet - volatilized surface materials. Jump in methane abundance - plus rich spectrum for surface material.

Analysis is underway to determine temperature history of inlet (not measured directly)

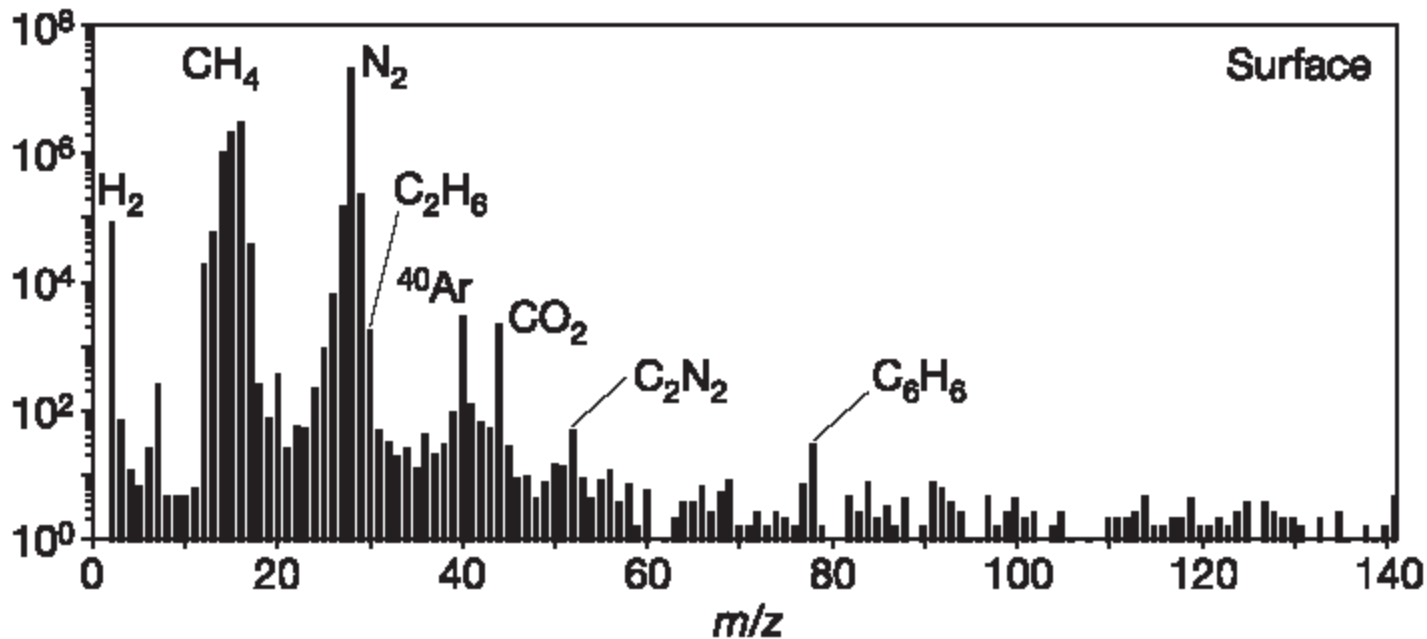
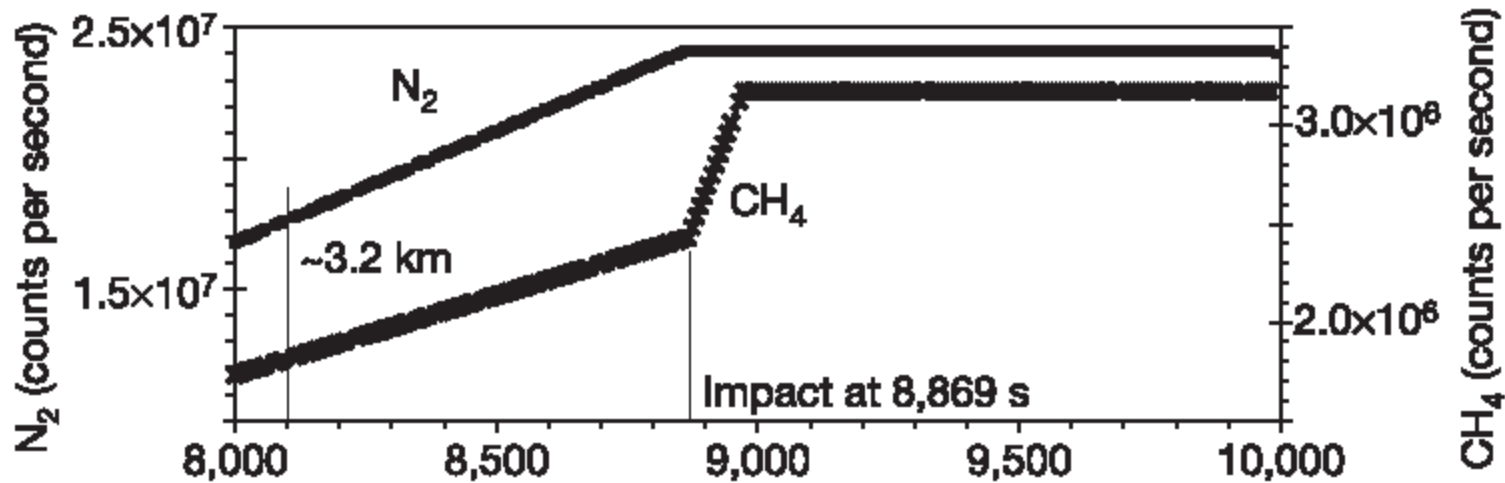

Huygens GCMS Inlet Line and Break off Cap

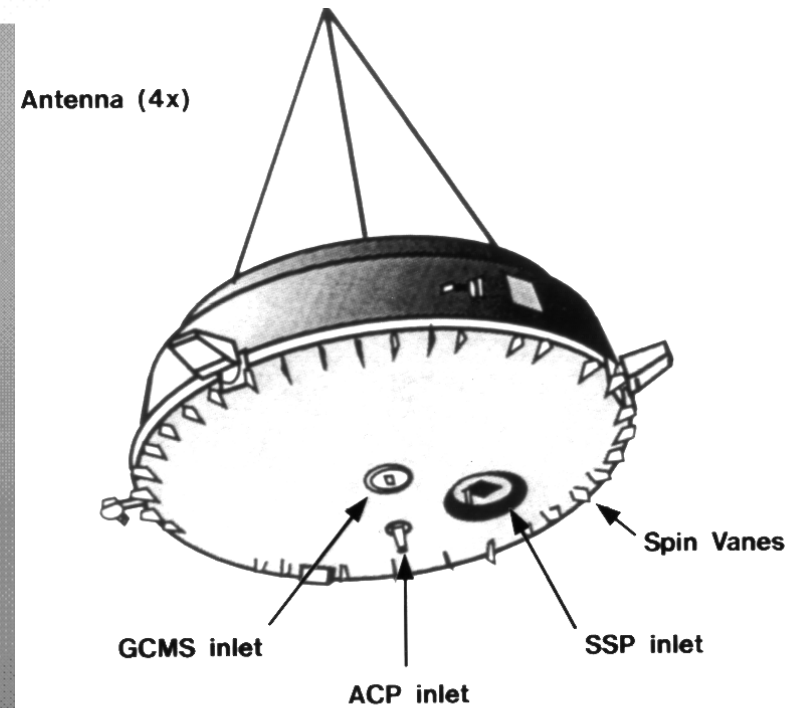
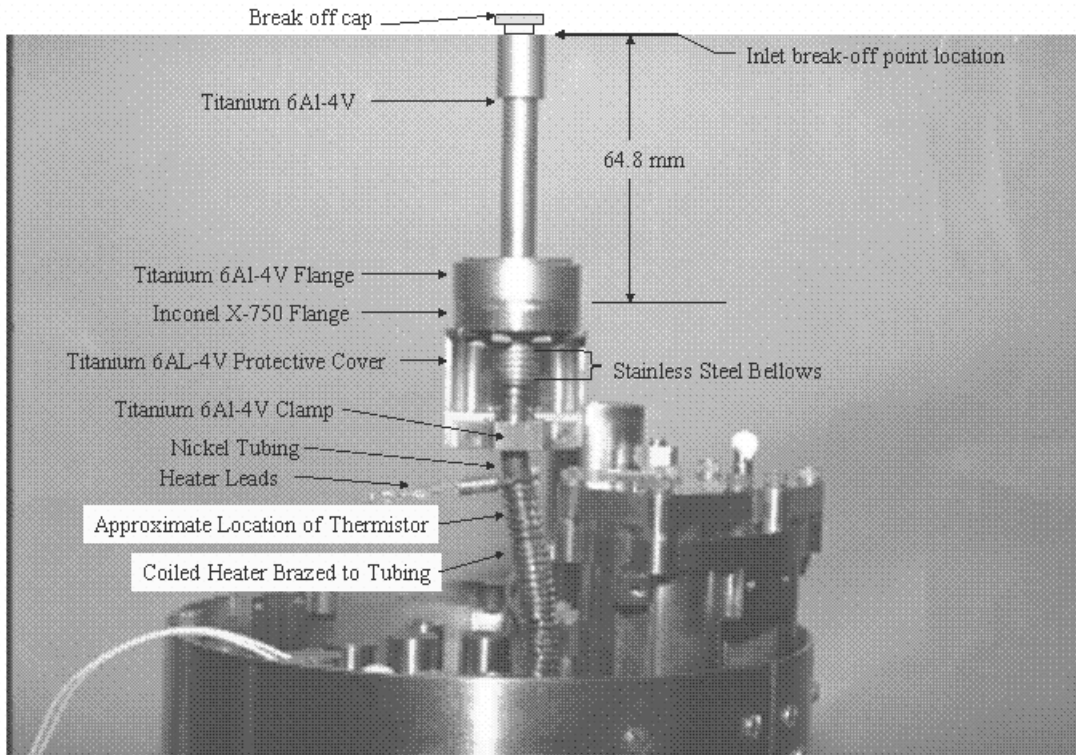

**3.5 node model
needed to
reconstruct the
temperature history**

**Meteoritics and
Planetary Science,
41, 1705-1714, 2007**

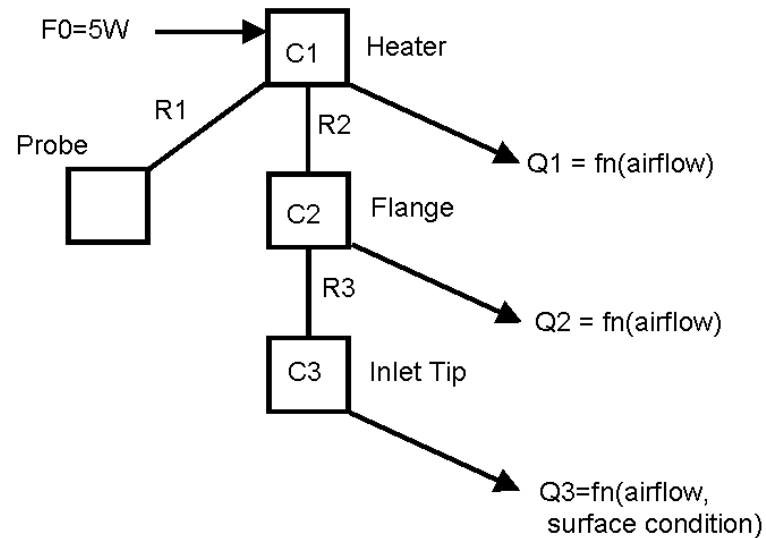

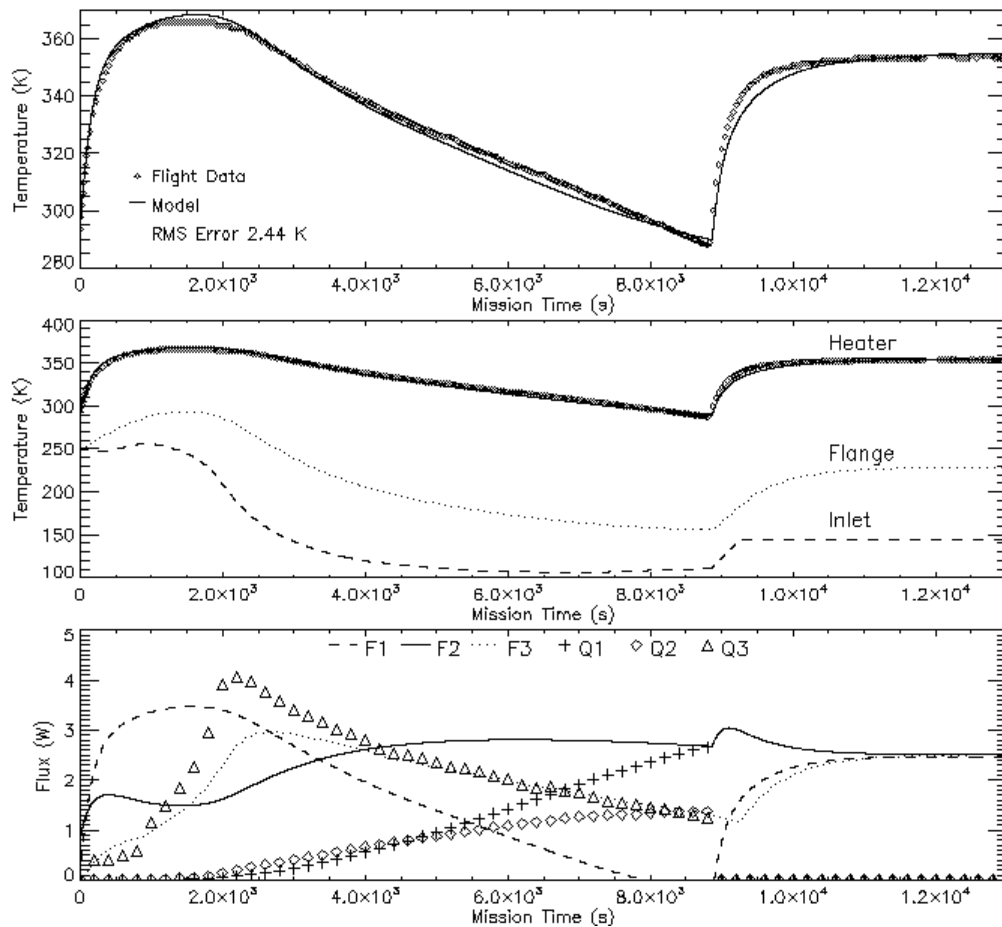

Free parameters in model can be tuned to reproduce descent history of inlet heater temperature.

Asymptotic inlet temperature (and thus effective surface thermal conductivity) is the result

Inferred 1-2 Wm⁻²K⁻¹ conductivity is too high for dry granular material – implies heat loss was enhanced by ethane/methane moisture causing convection/evaporation (ground was damp)

Note clathrate decomposition temperature is not reached – evolved methane must have been present as a liquid.

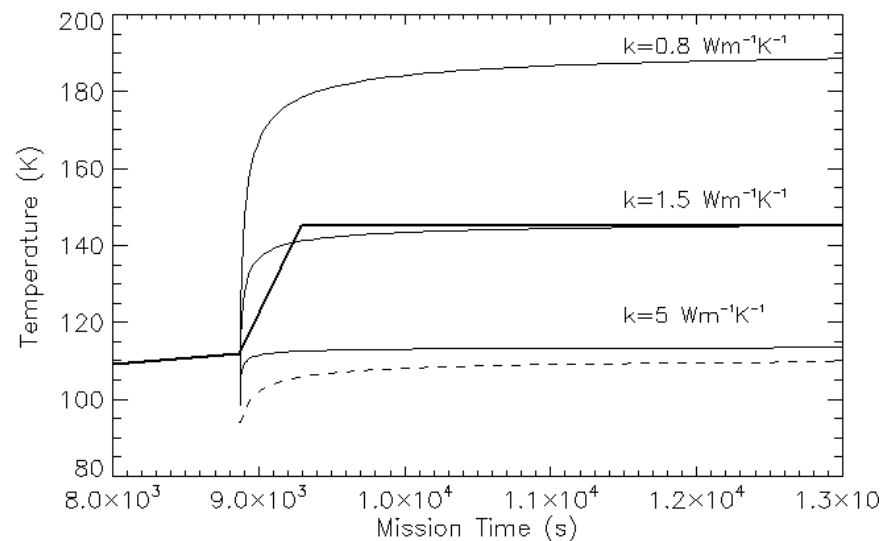

Coordinated Huygens Publications

- Nature, 8 Dec 2005, Vol 405
- Planetary and Space Science, Titan as seen from Huygens, Vol 55, Issue 13, November 2007
- Planetary and Space Science, Titan as seen from Huygens, Volume 56, Issue 5, April 2008, Pages 573-585
- Huygens archived data set on ESA's PSA (<http://www.rssd.esa.int/PSA>)
mirrored to NASA PDS atmospheric node: <http://atmos.nmsu.edu/>

But indeed all the whole story of Comets and Planets, and Production of the World, is founded upon such poor and trifling grounds, that I have often wonder'd how an ingenious man could spend all that pains in making such fancies hang together. For my part, I shall be very well contented, and shall count that I have done a great matter, if I can but come to any knowledge of the nature of things, as they now are, never troubling my head about their beginning, or how they were made, knowing that to be out of the reach of human Knowledge, or even Conjecture.

Christiaan Huygens, 1698

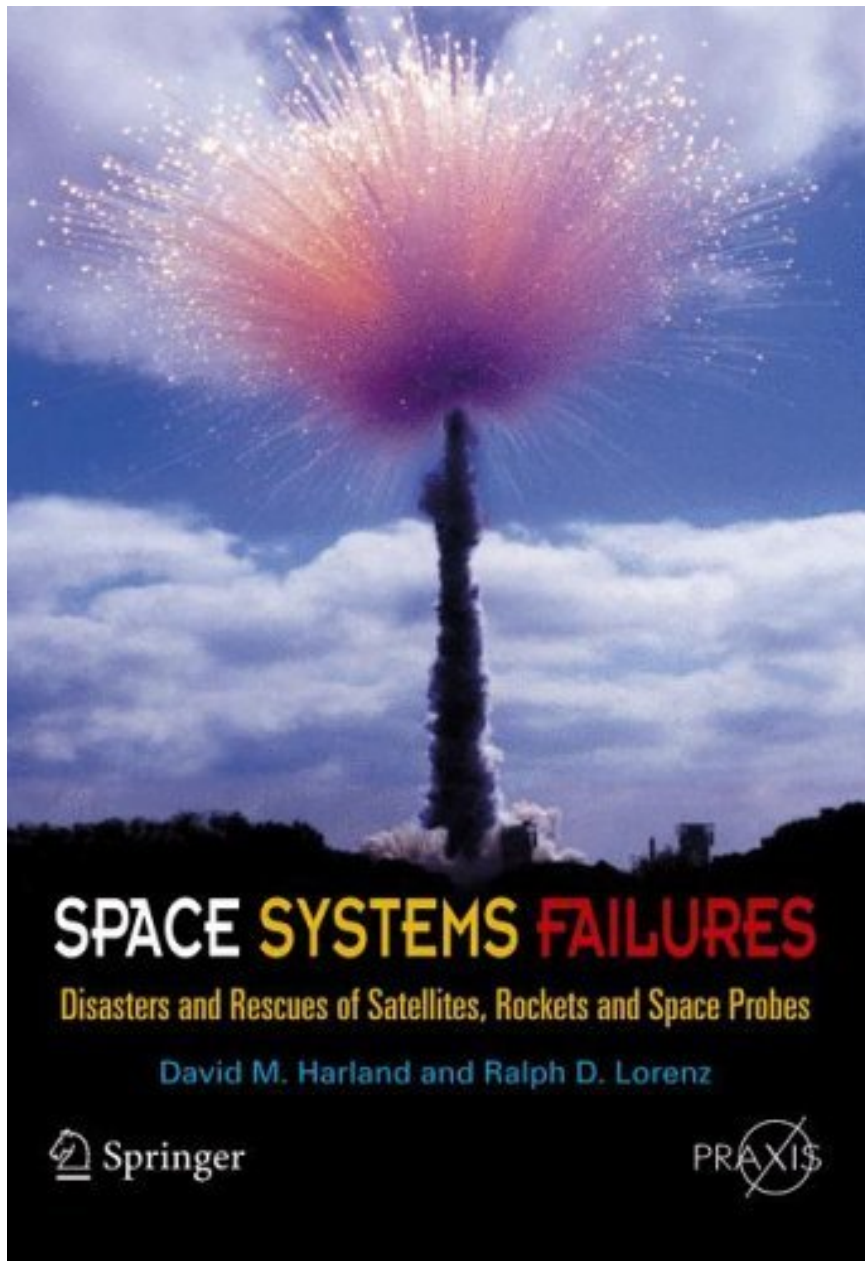

**Springer 2005. Chinese
edition 2010**

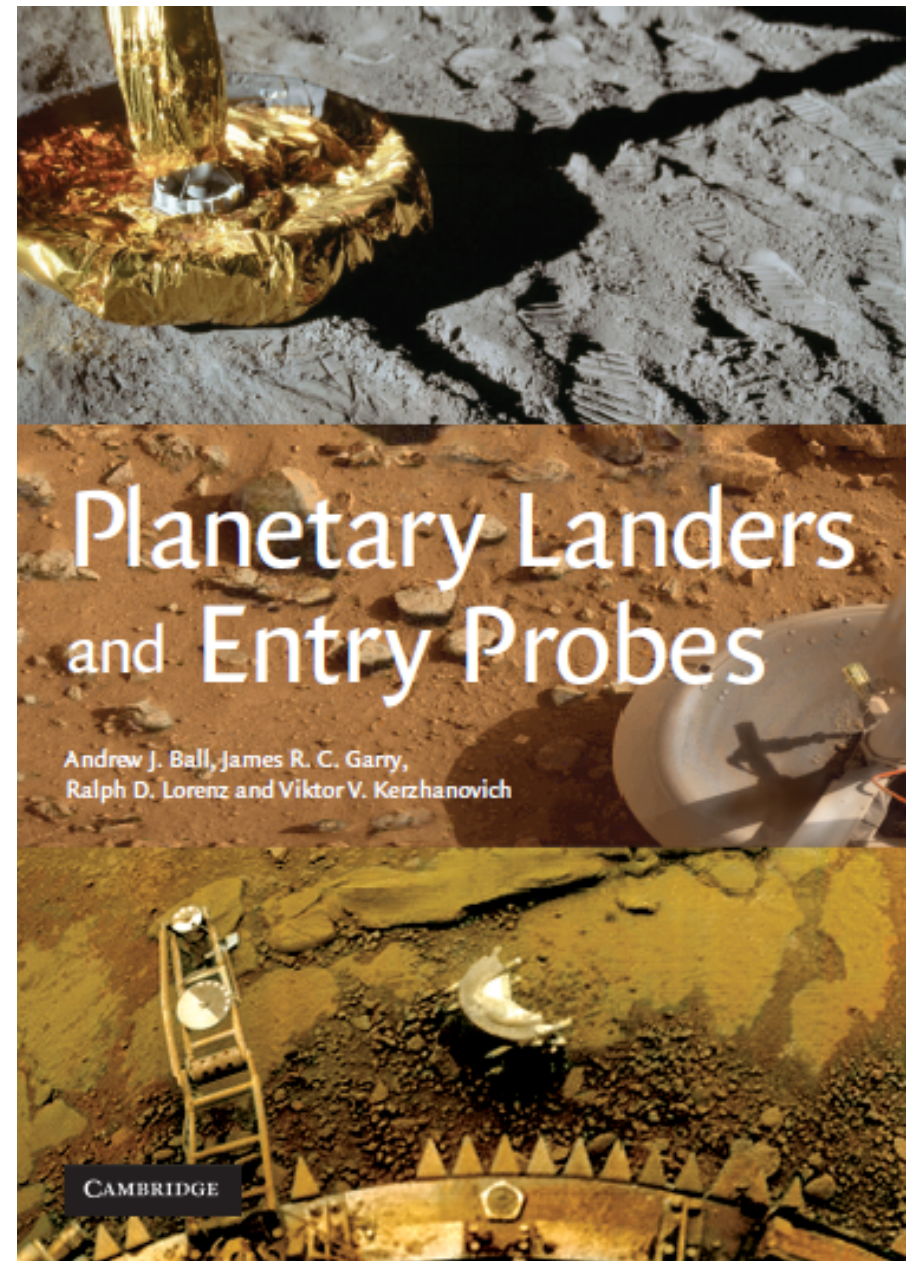

**CUP 2007. Chinese
edition forthcoming**